



Mijn Interactieve Werkbank

Projectgids



Niveau 1

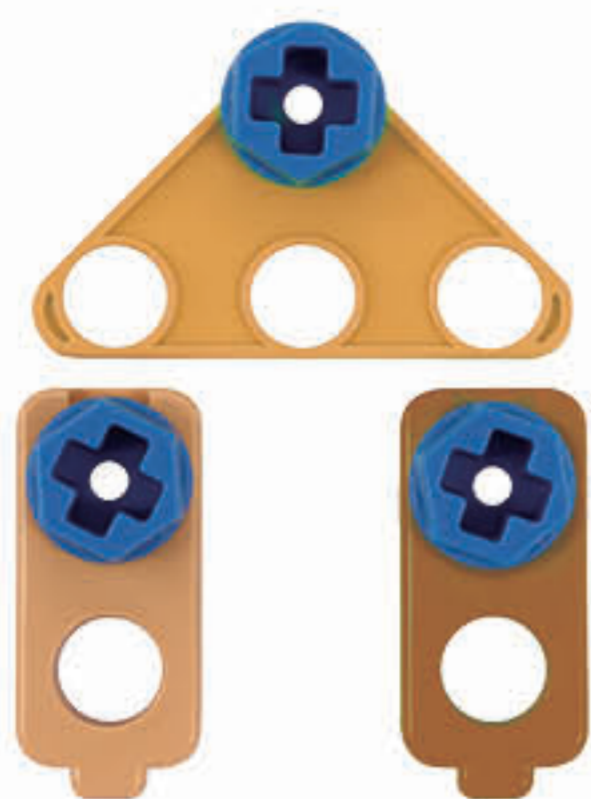

001

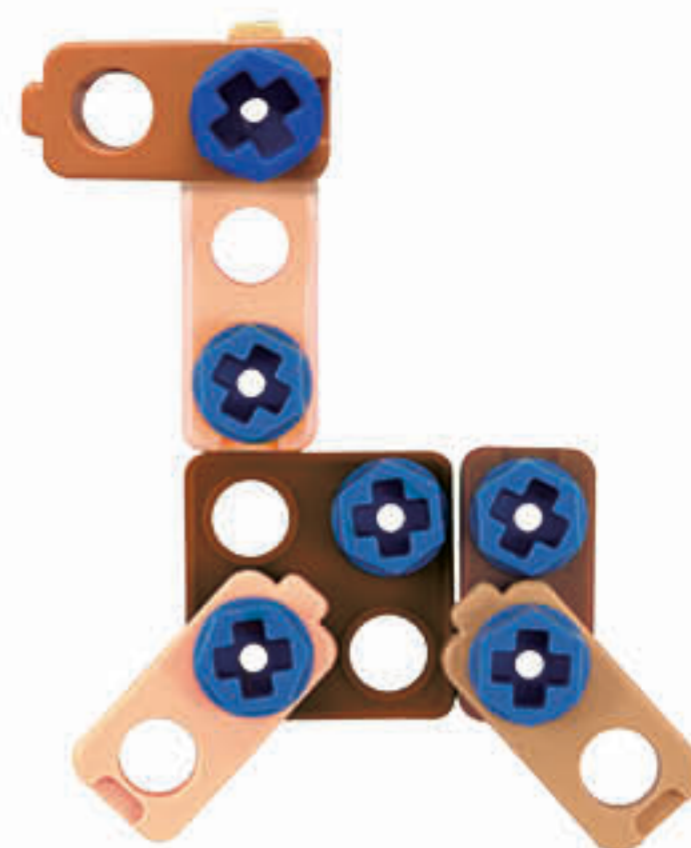

002

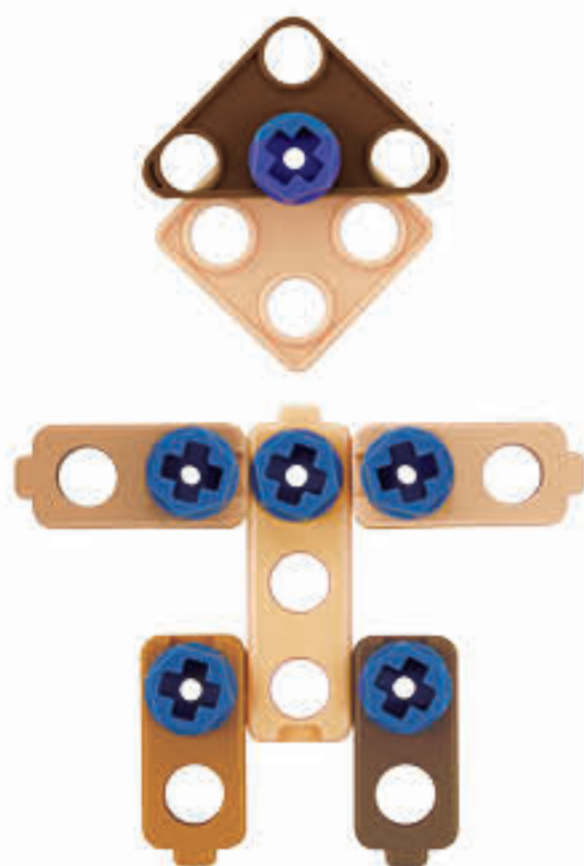

003

Nieuw!

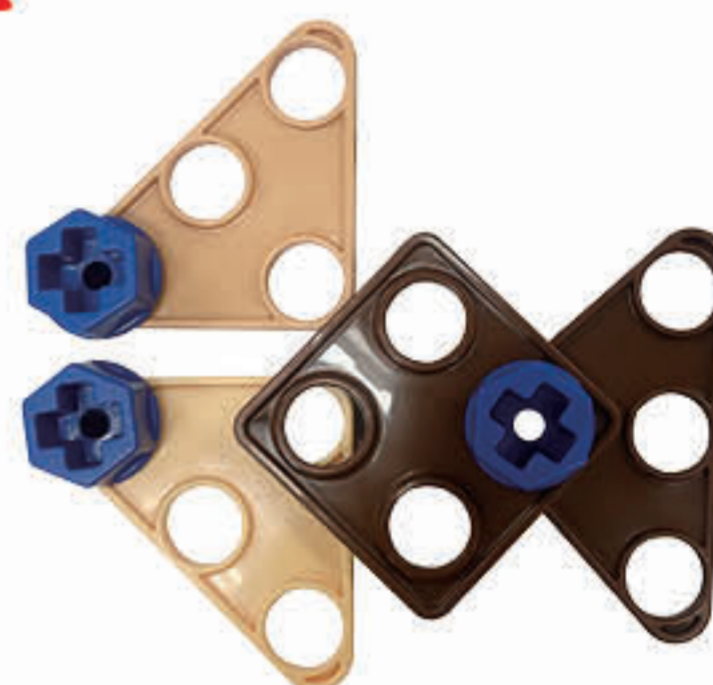

004

Nieuw!

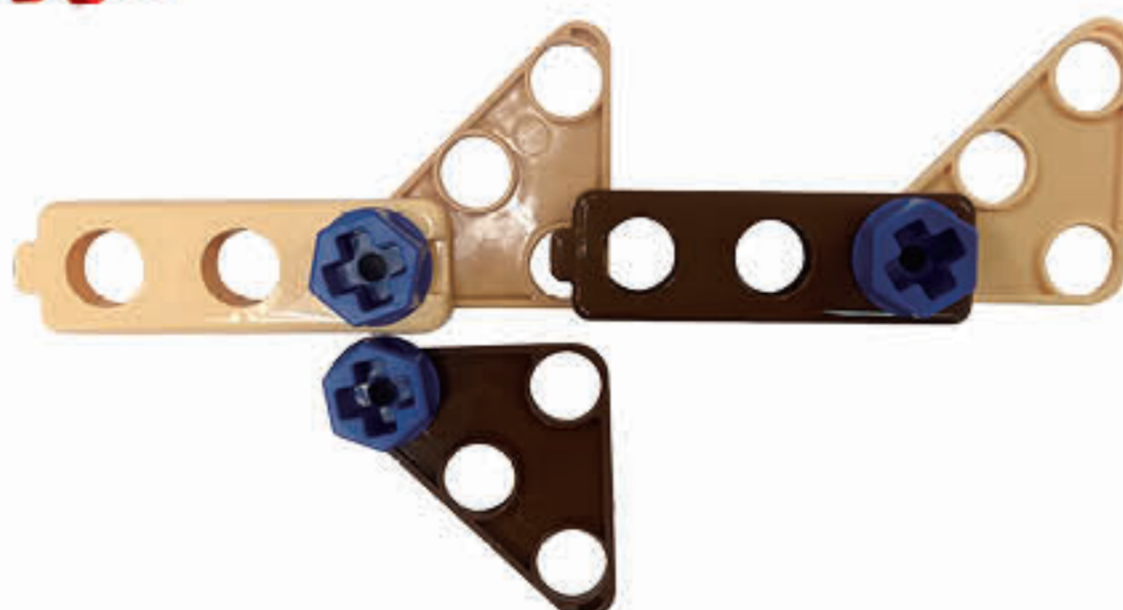

005

Niveau 3



011



012

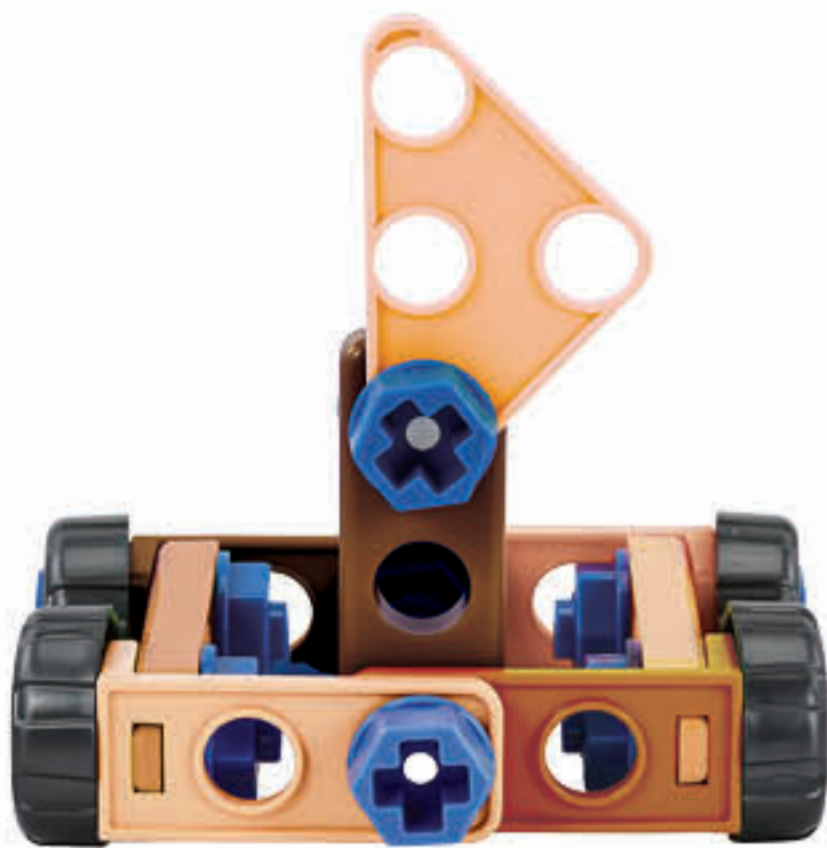

013

Nieuw!



014

Nieuw!



015

Niveau 1

001

x1 x1

x1 x3

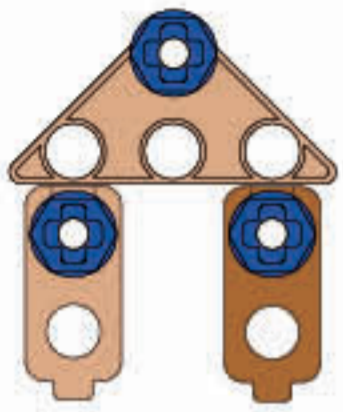

1

x1 x1
x3

Boven-
aanzicht

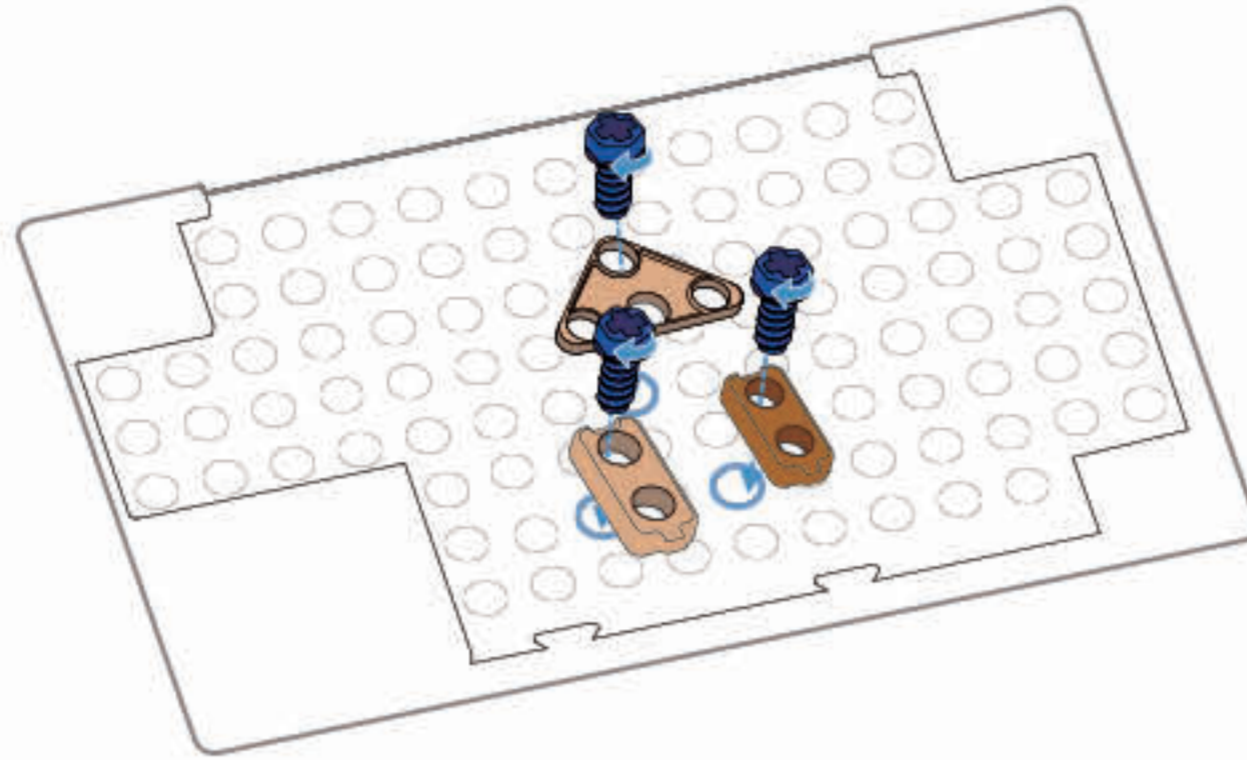

Goed werk!
Het is je gelukt!



002

x1
x1 x1
x1 x1
x1 x6

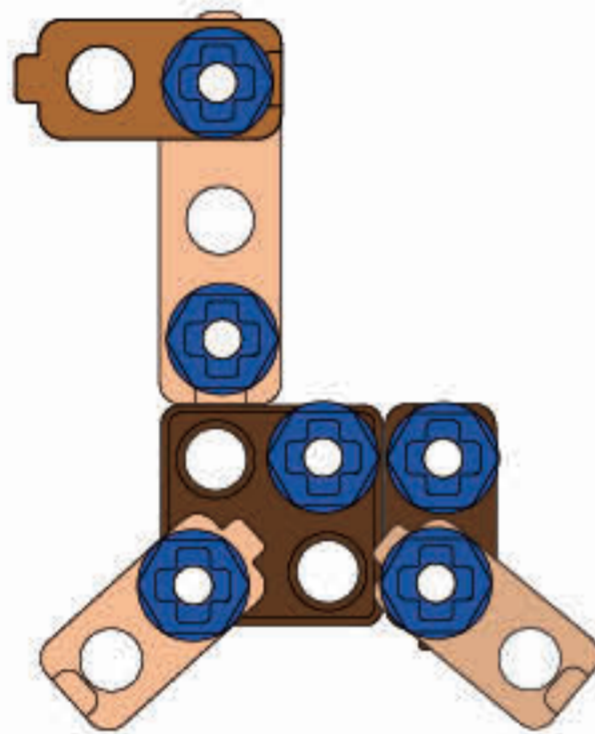

1

x1 x1
x3 x1

Boven-
aanzicht

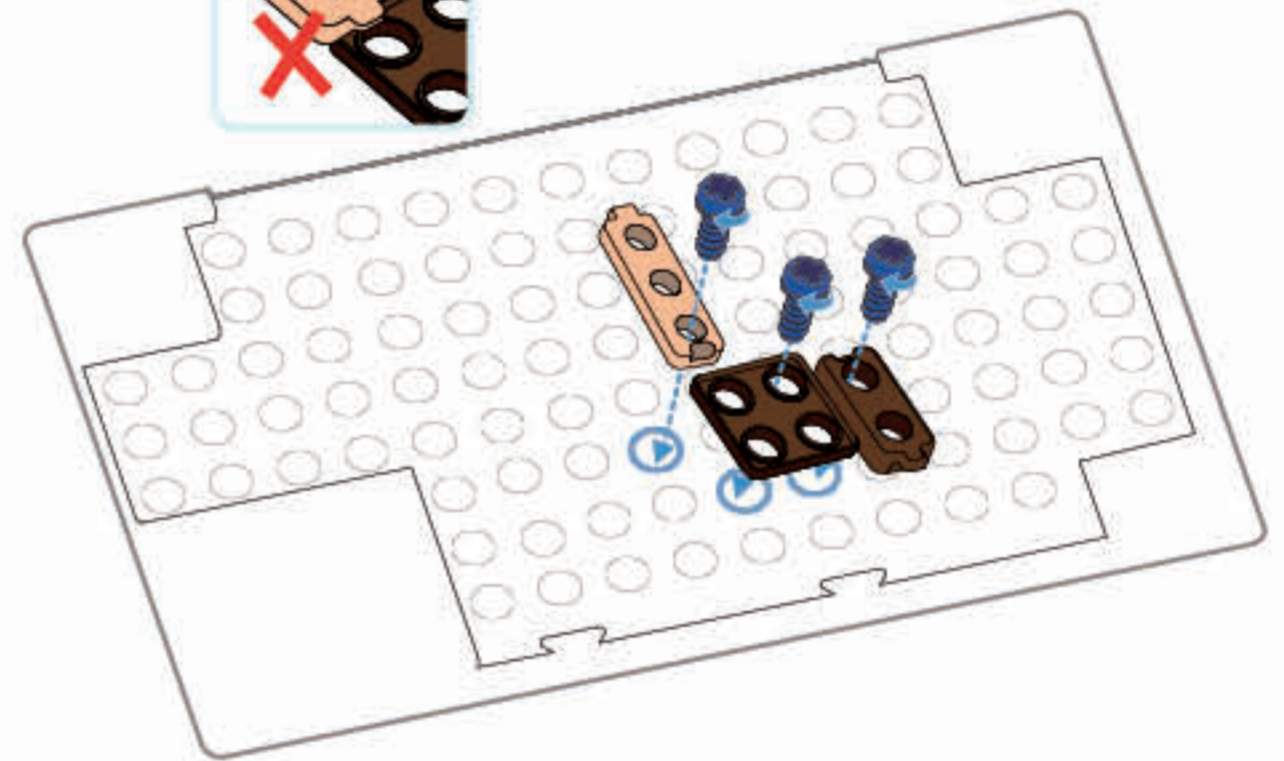

2

x1 x1
x1 x3

Boven-
aanzicht

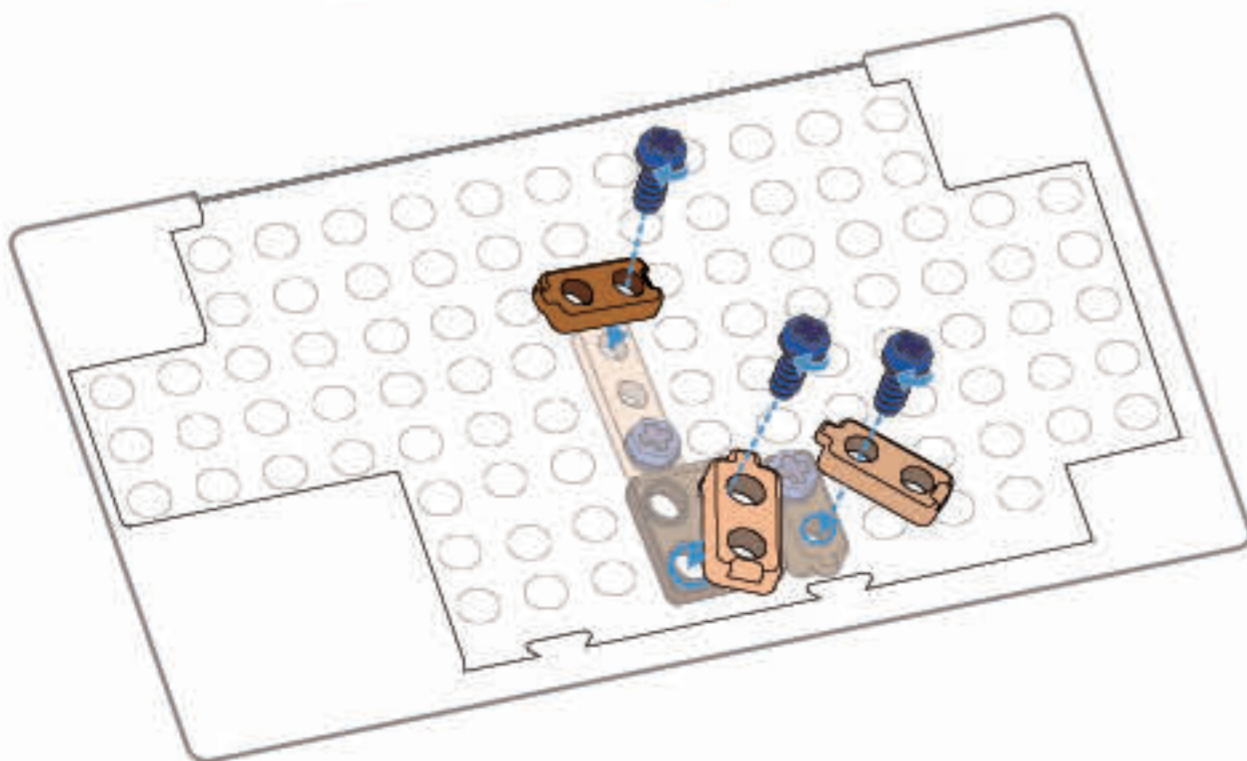

Goed werk!
Het is je gelukt!



003

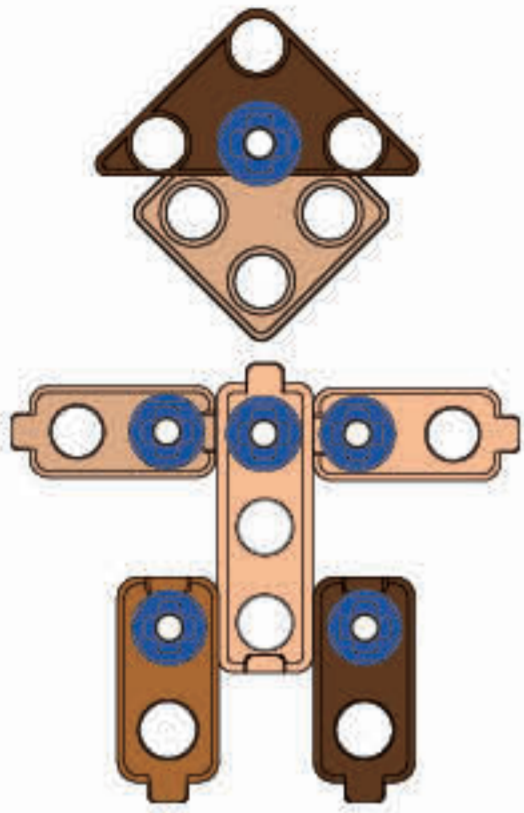
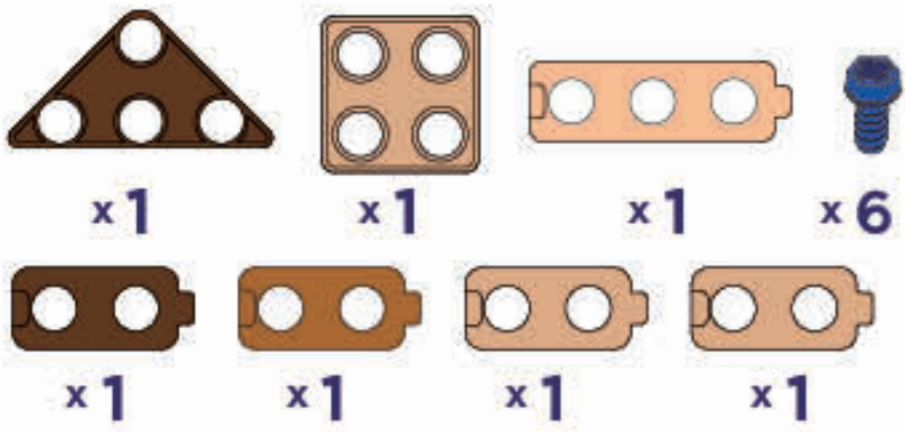

1

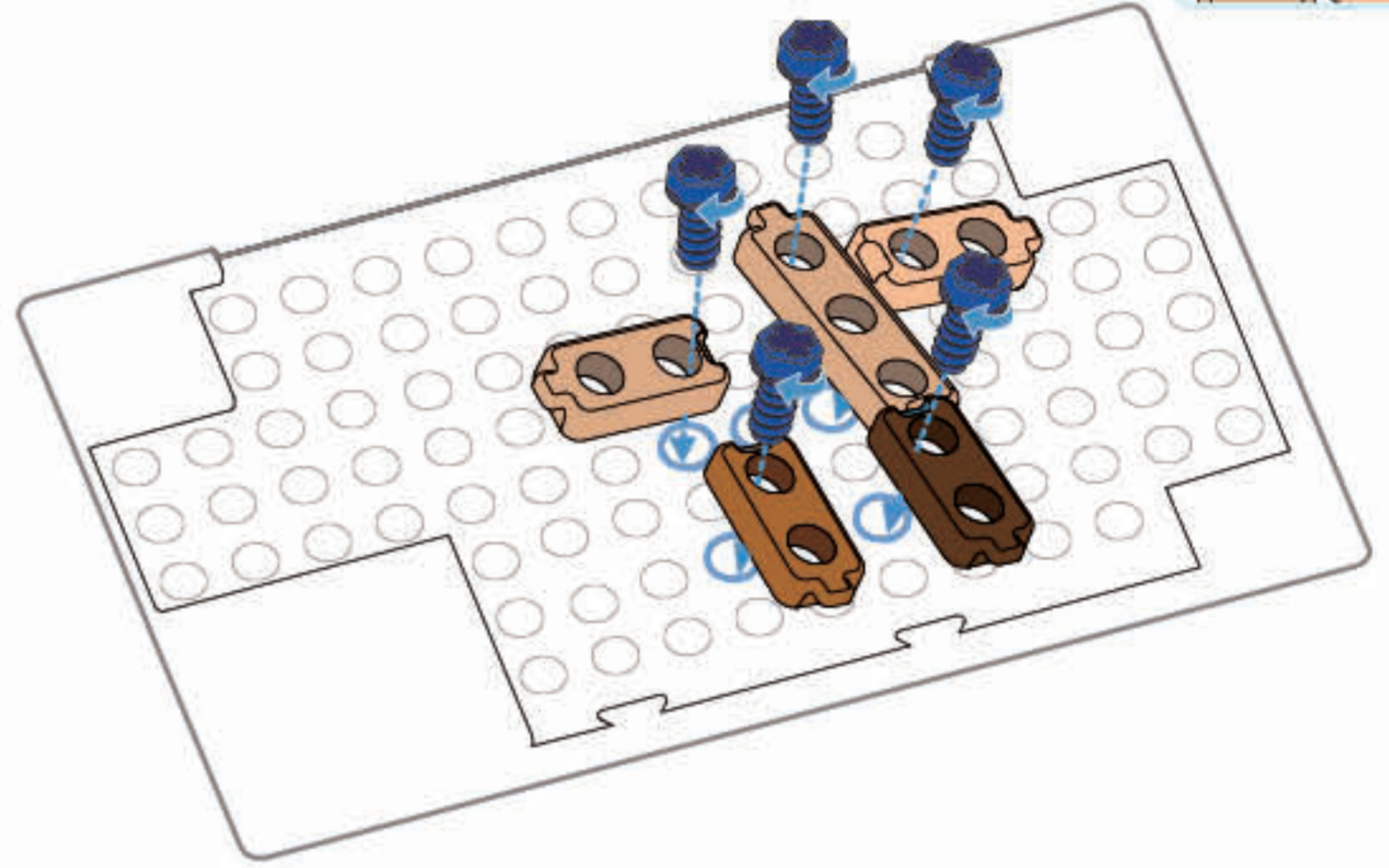
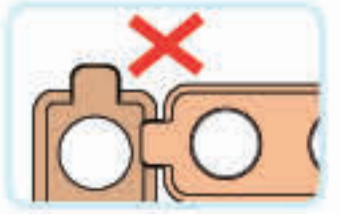
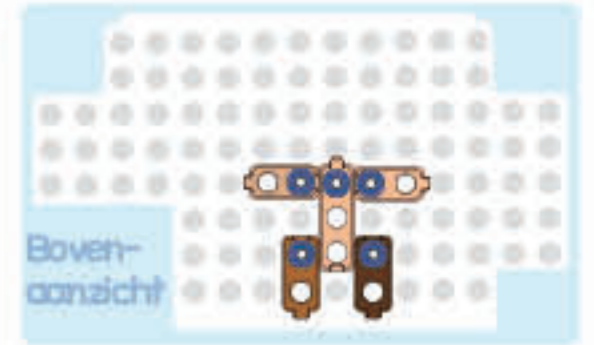
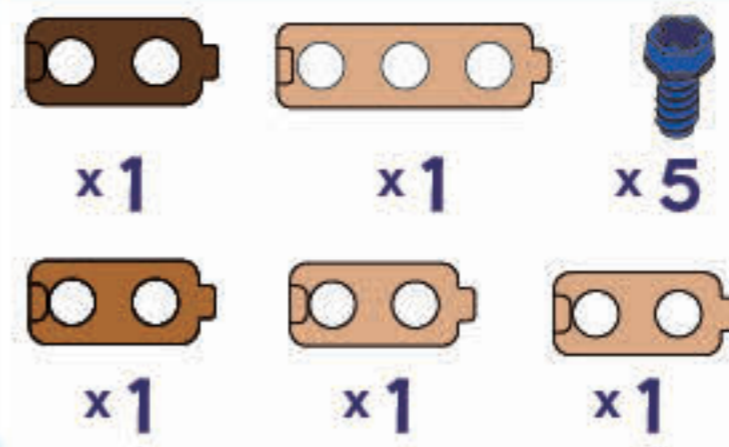

2

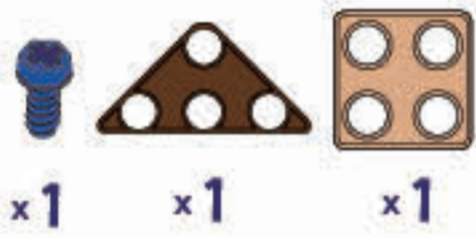

Goed werk!
Het is je gelukt!

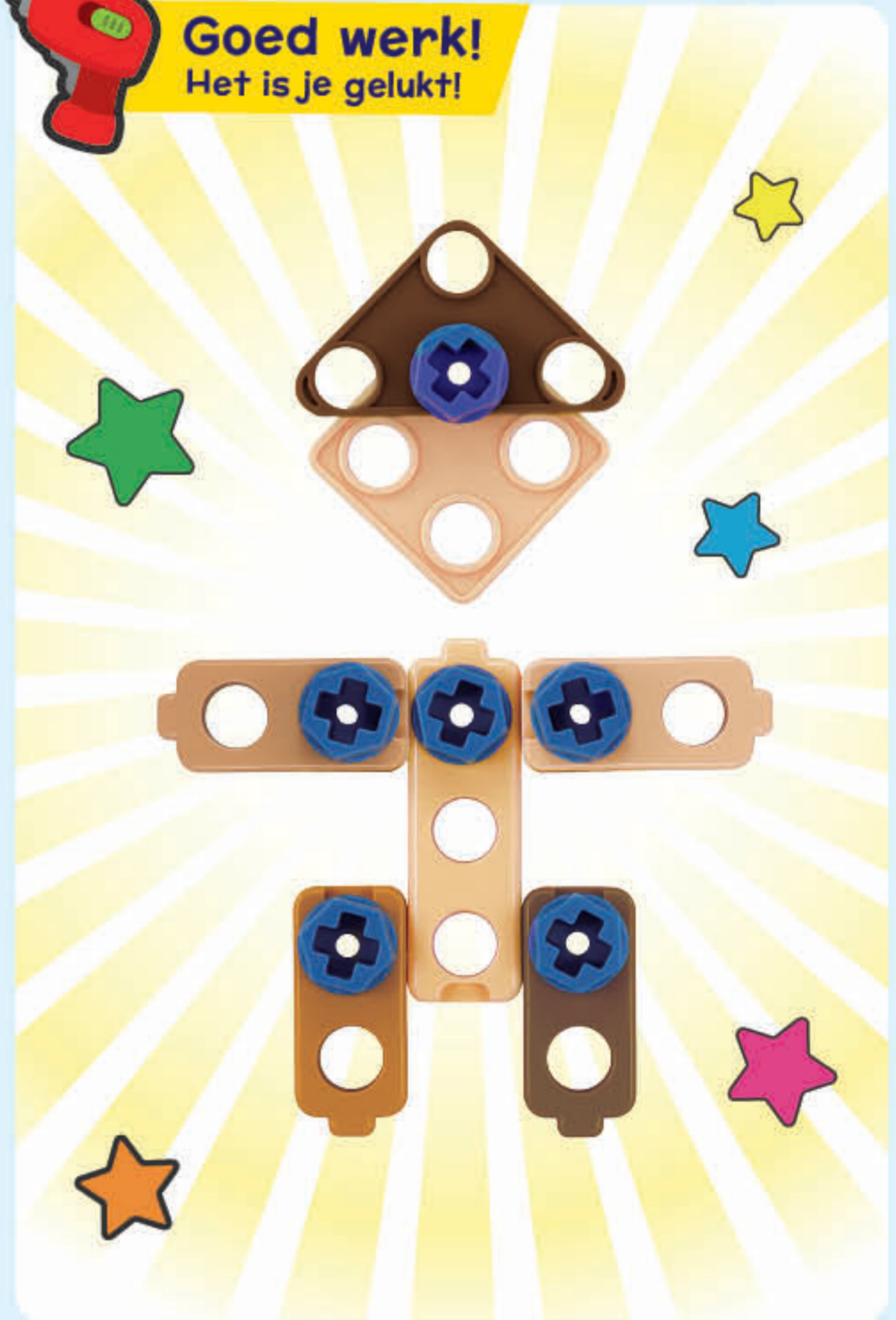
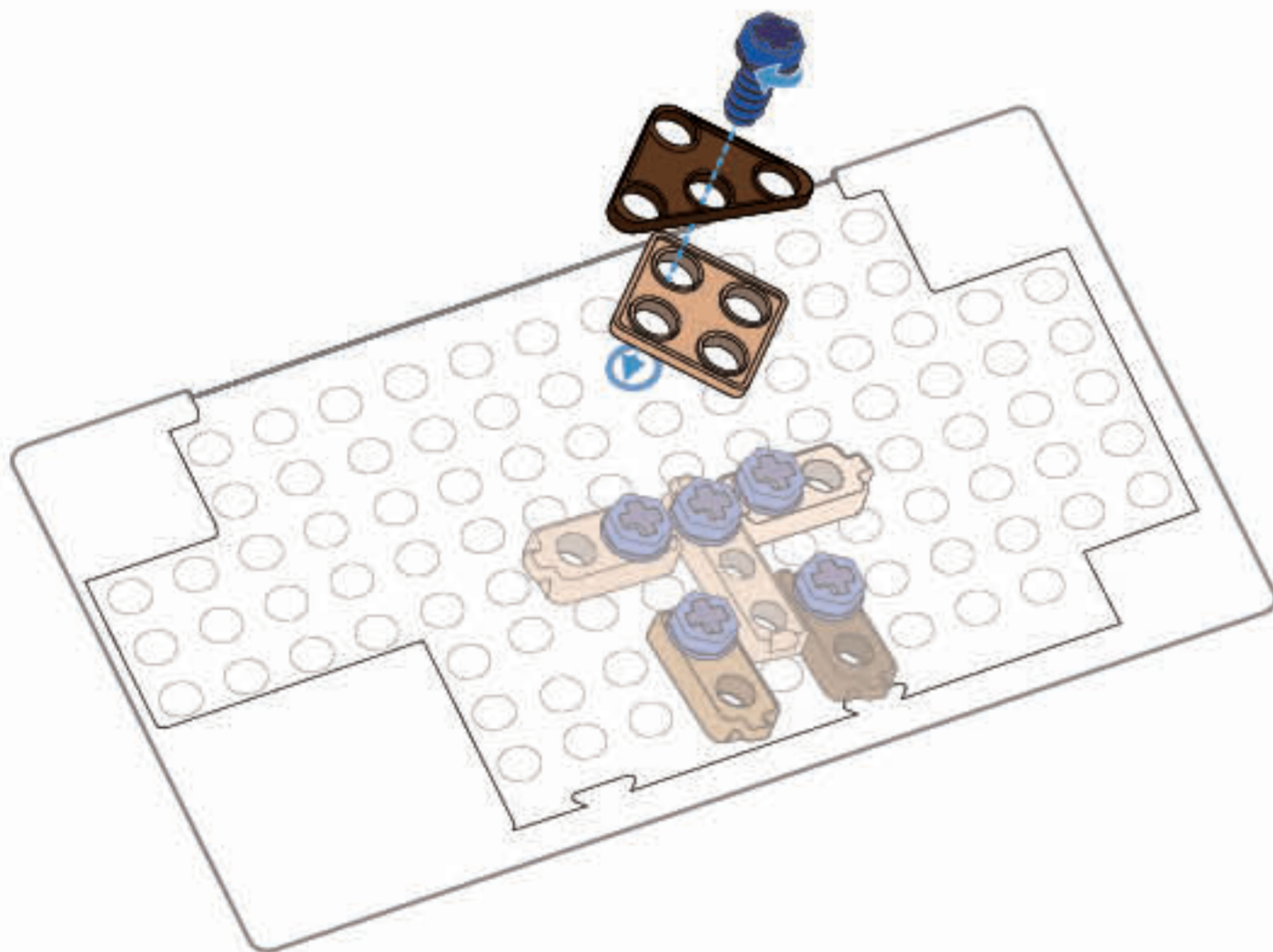

004

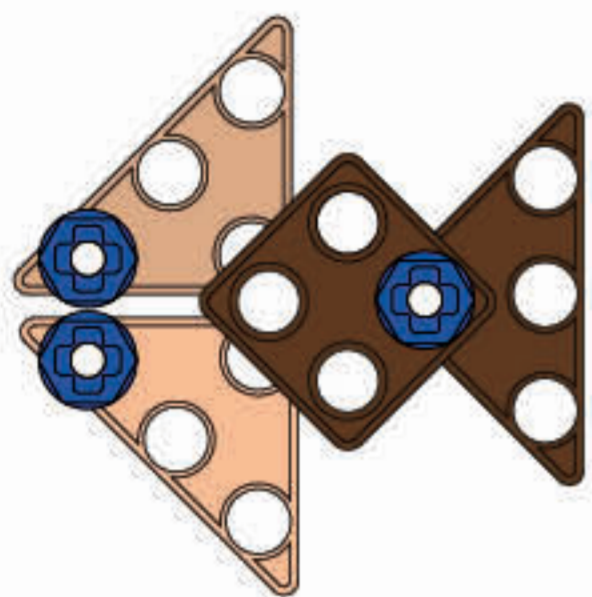
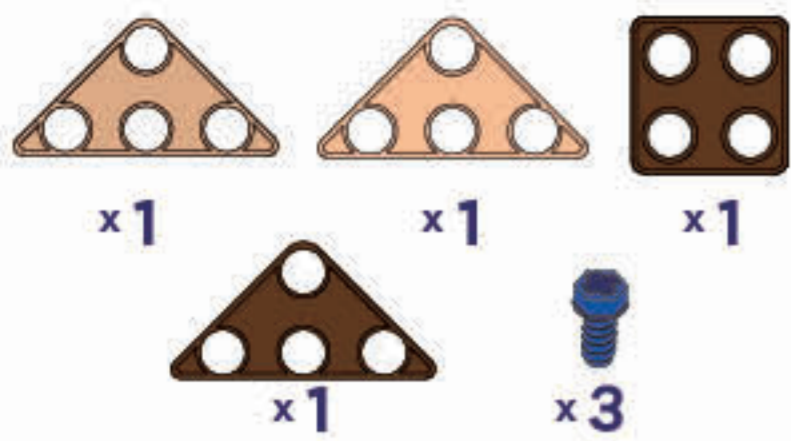

1

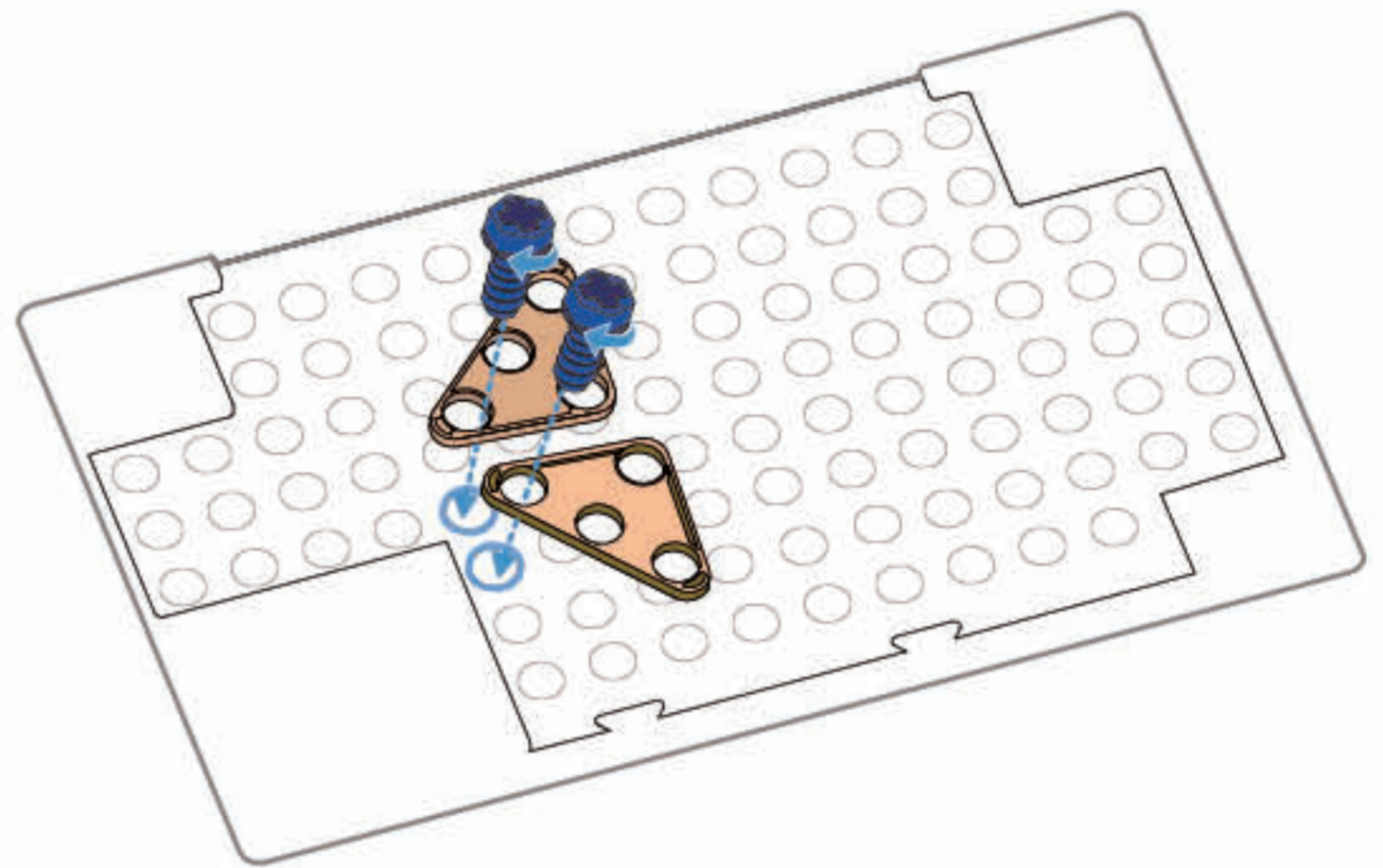
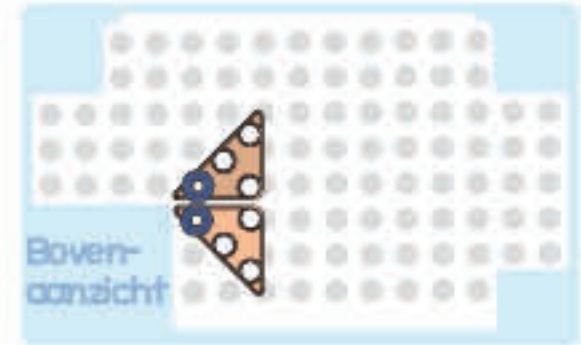
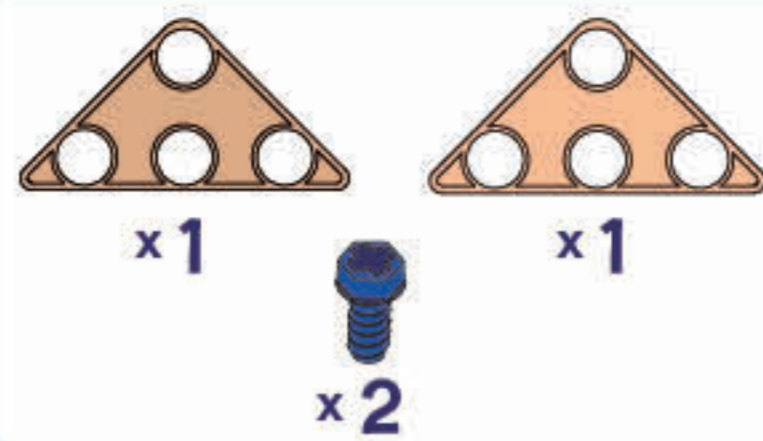

2

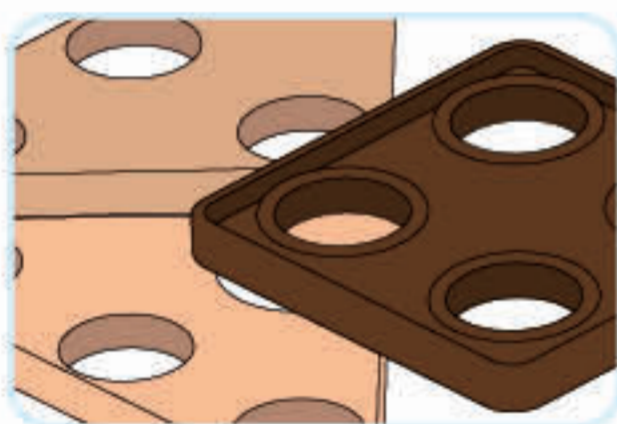
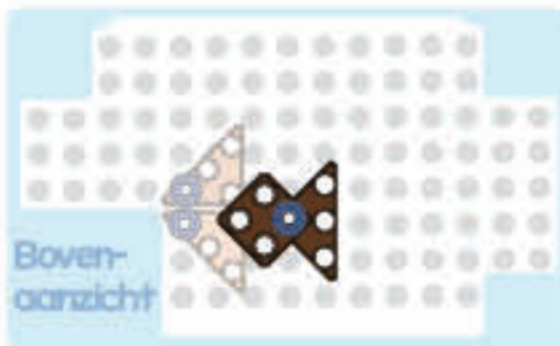
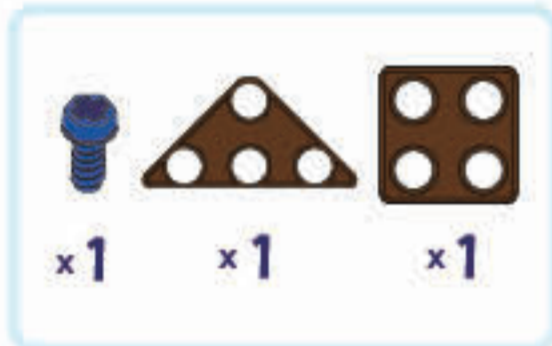

Goed werk!
Het is je gelukt!

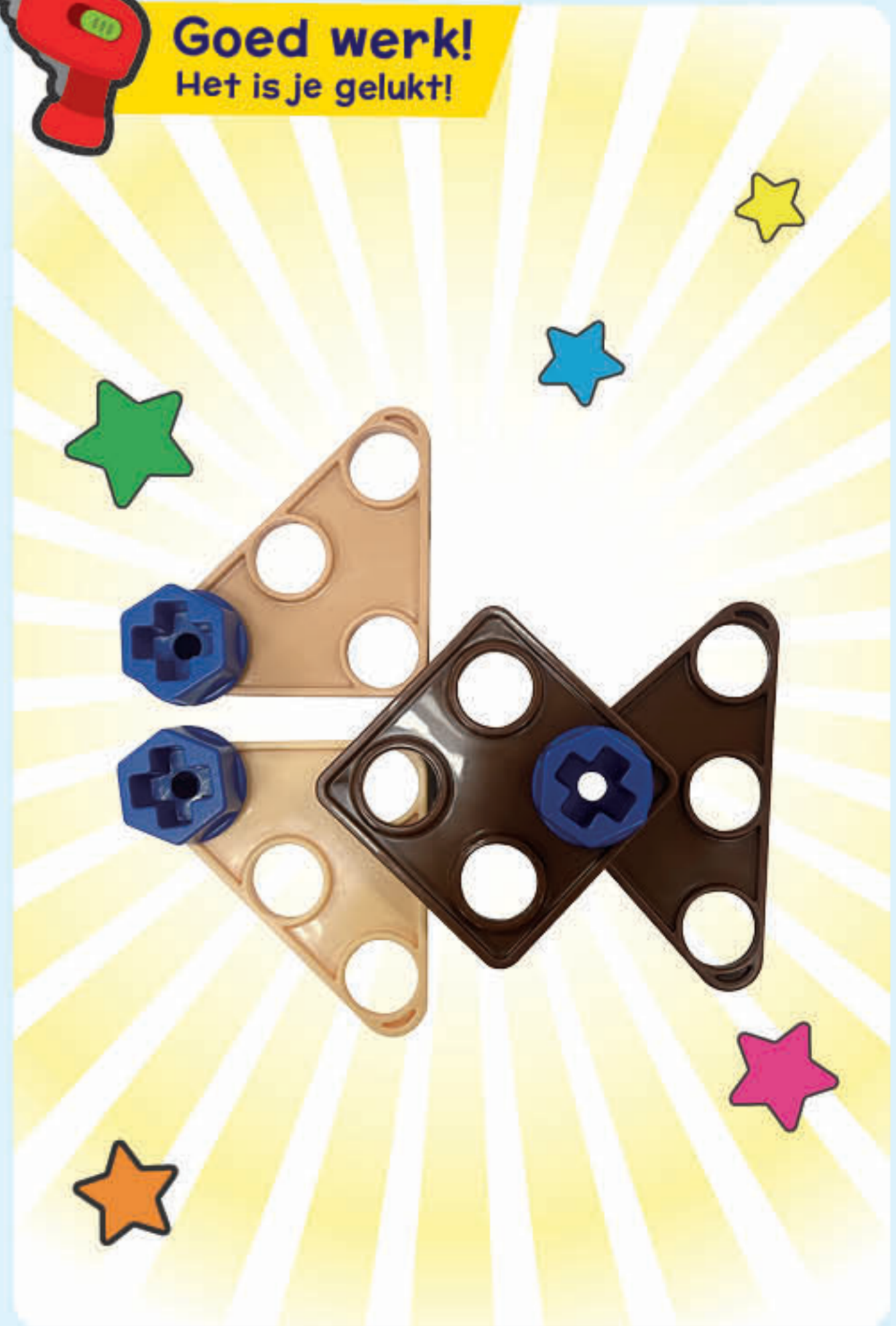

005

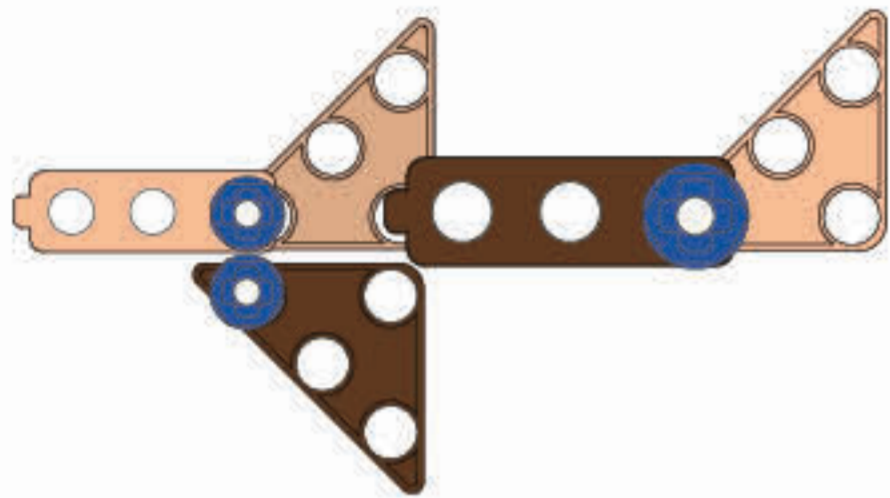
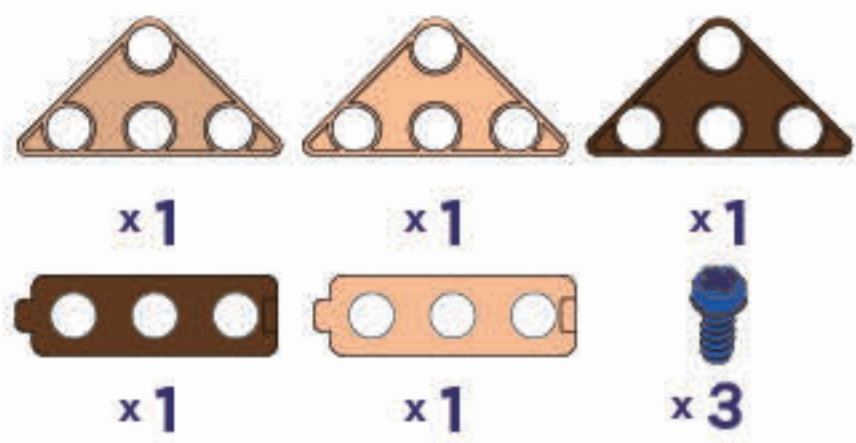

1

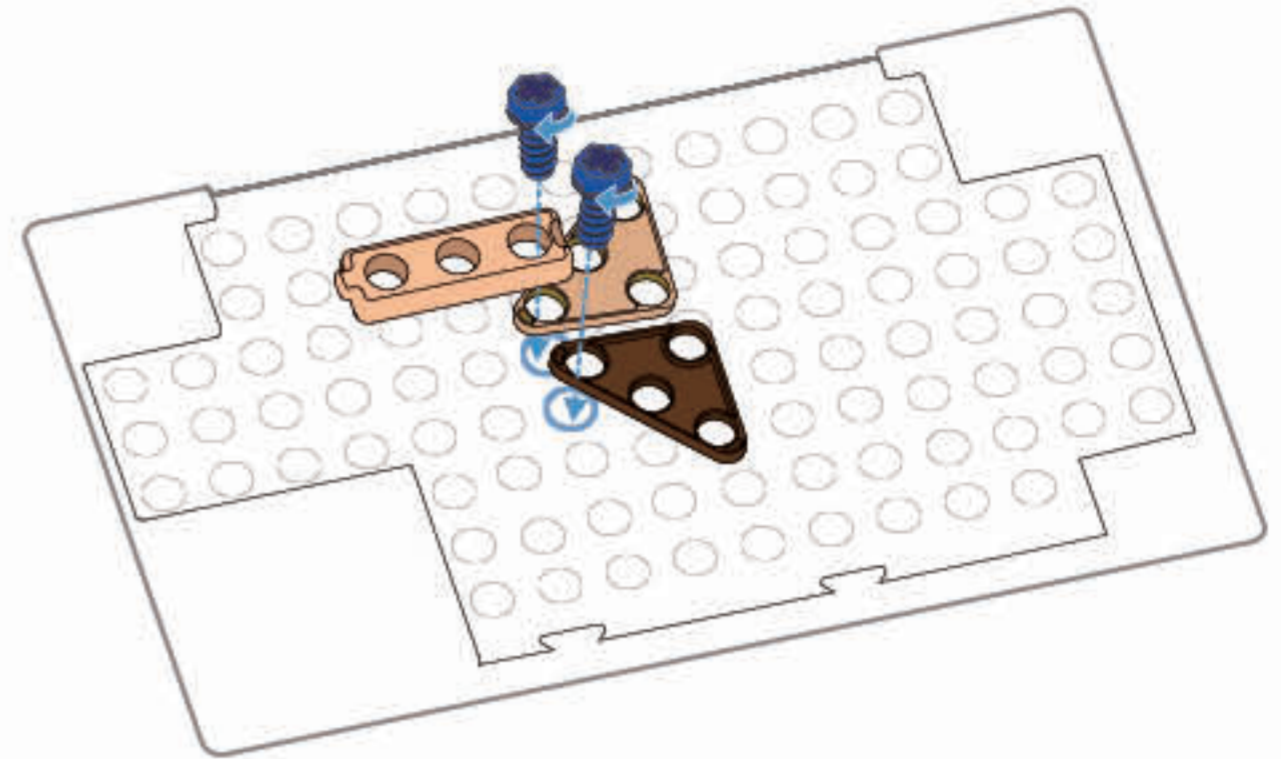
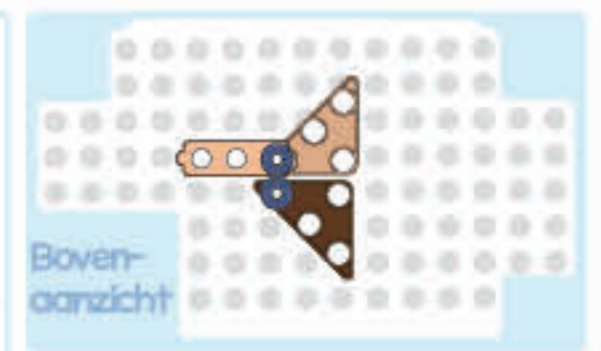
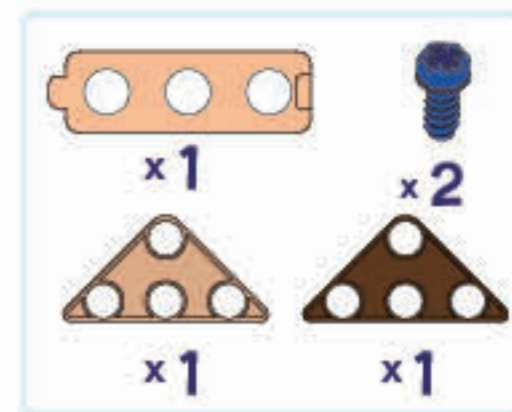

2

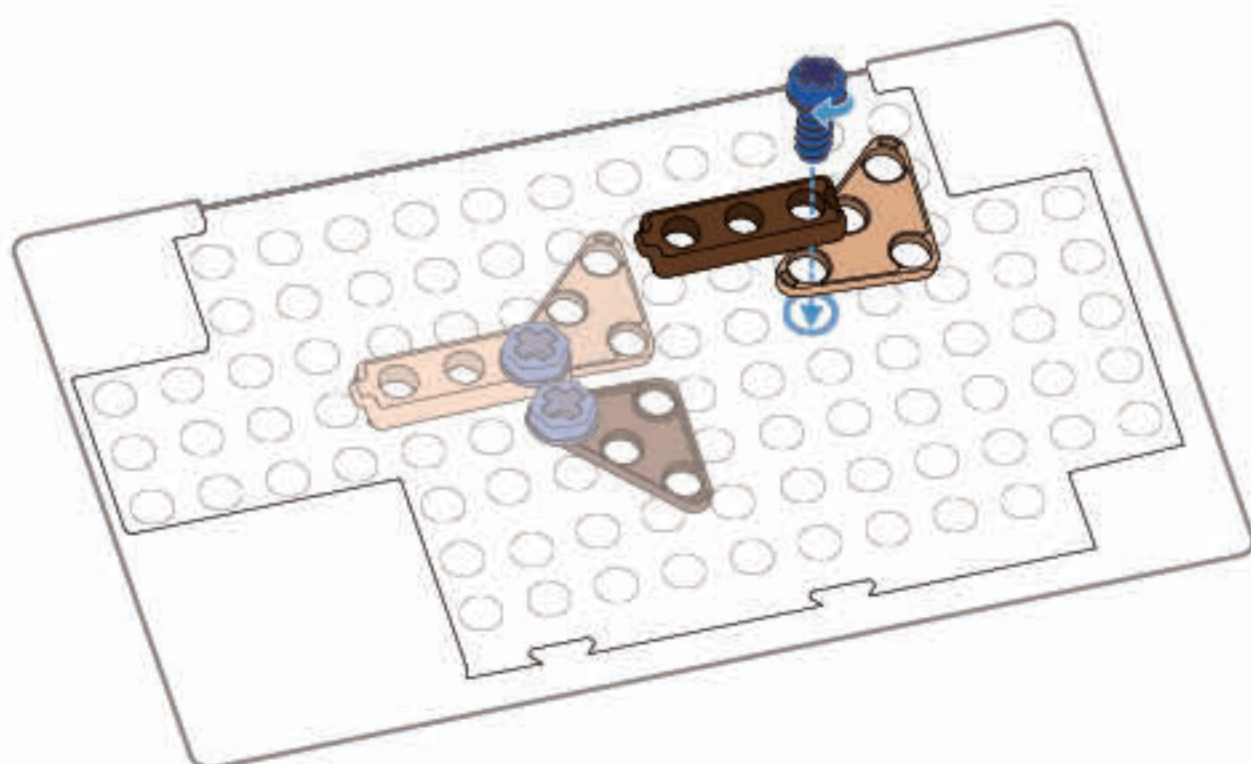
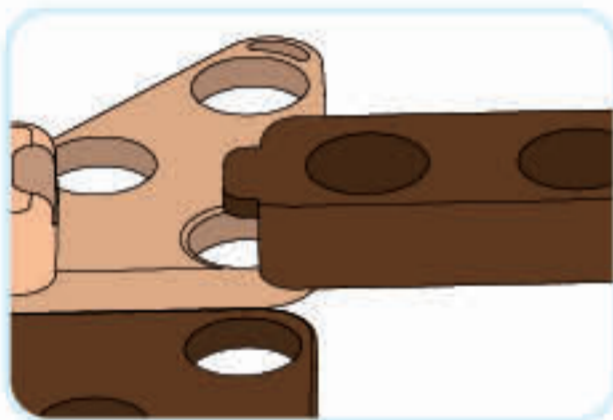
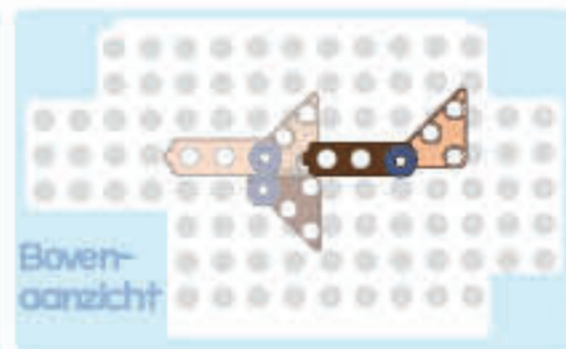
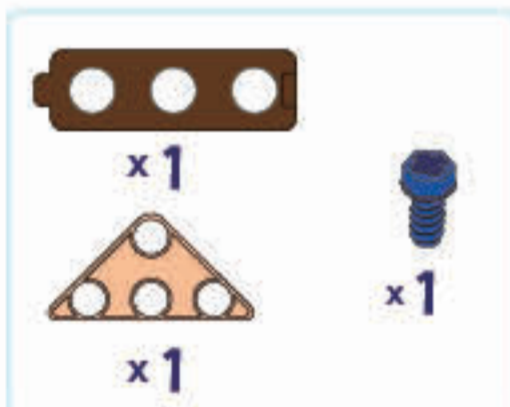

Goed werk!
Het is je gelukt!

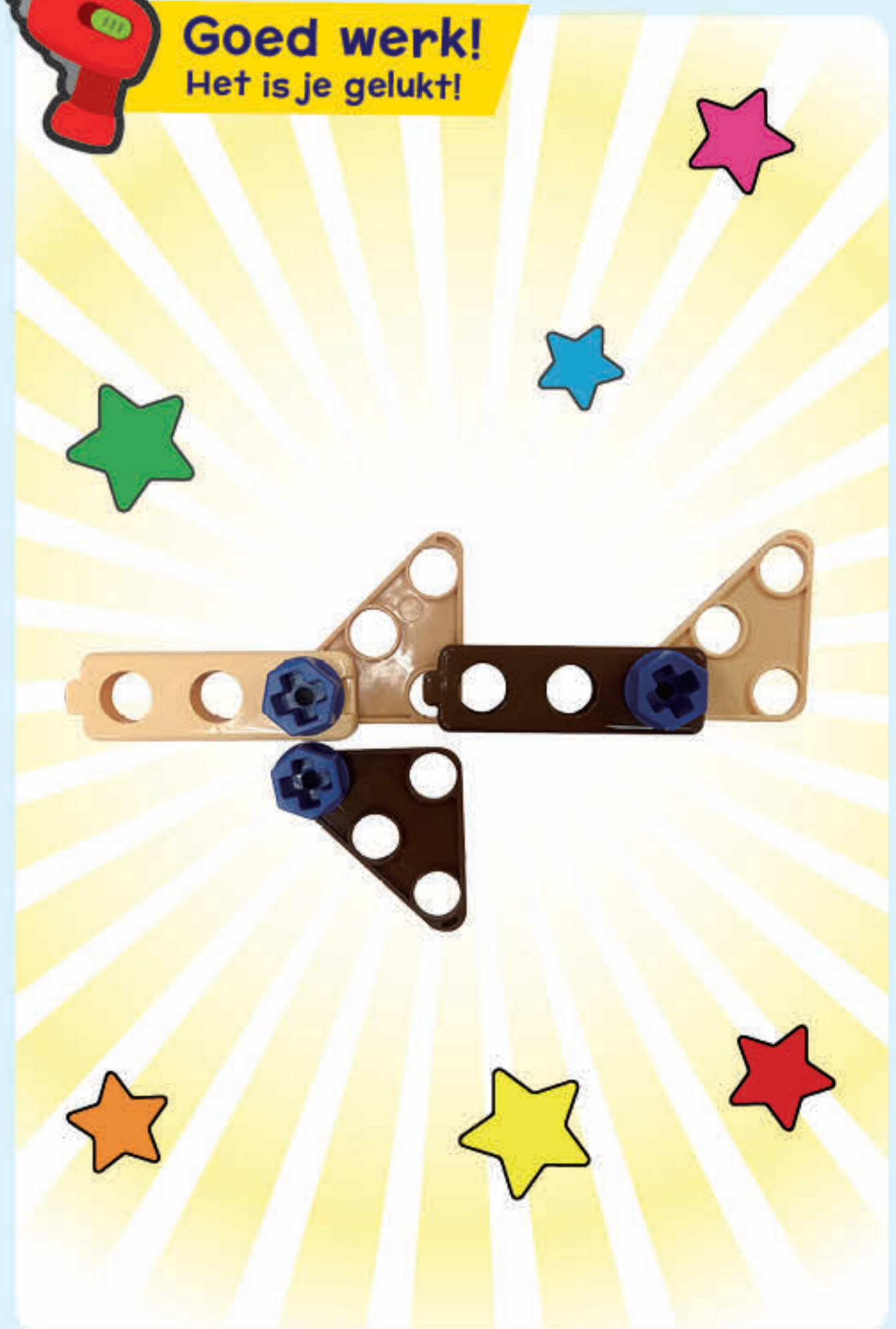

Niveau 2

006

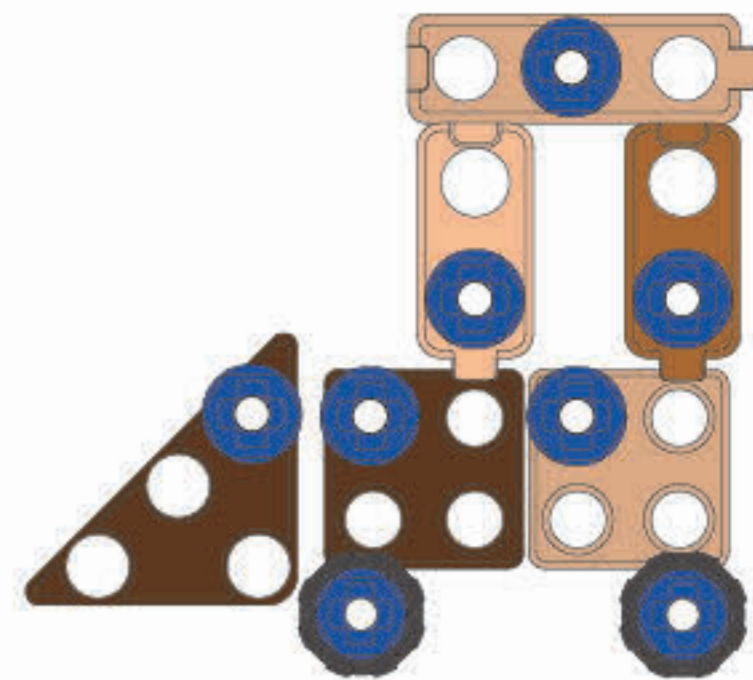
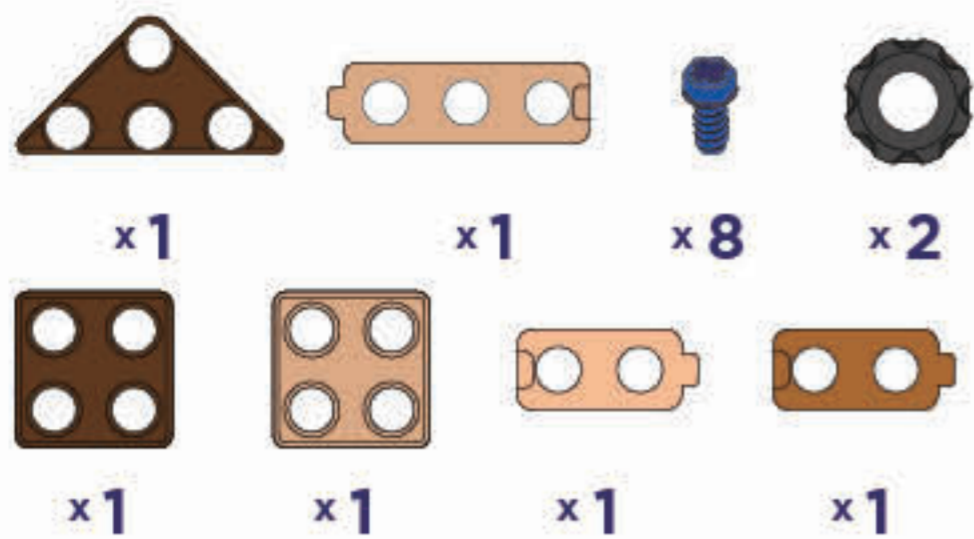

1

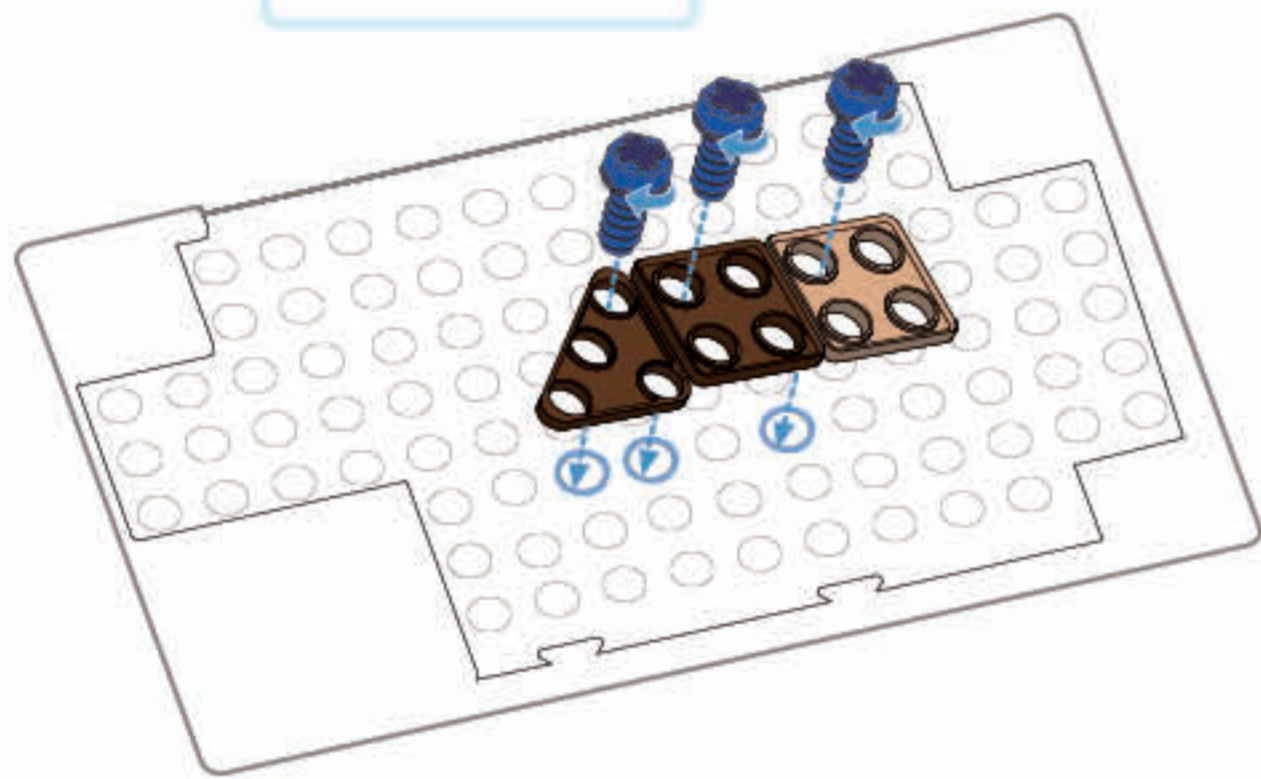
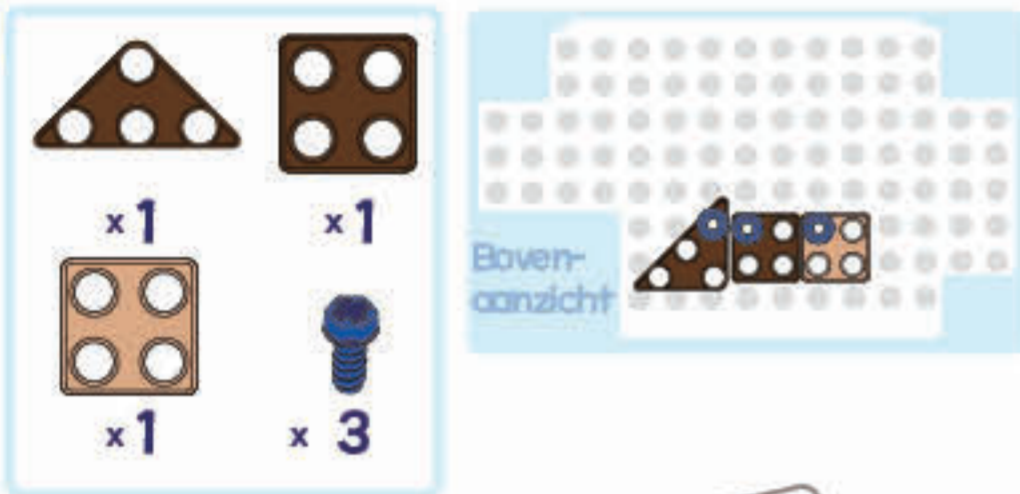

2

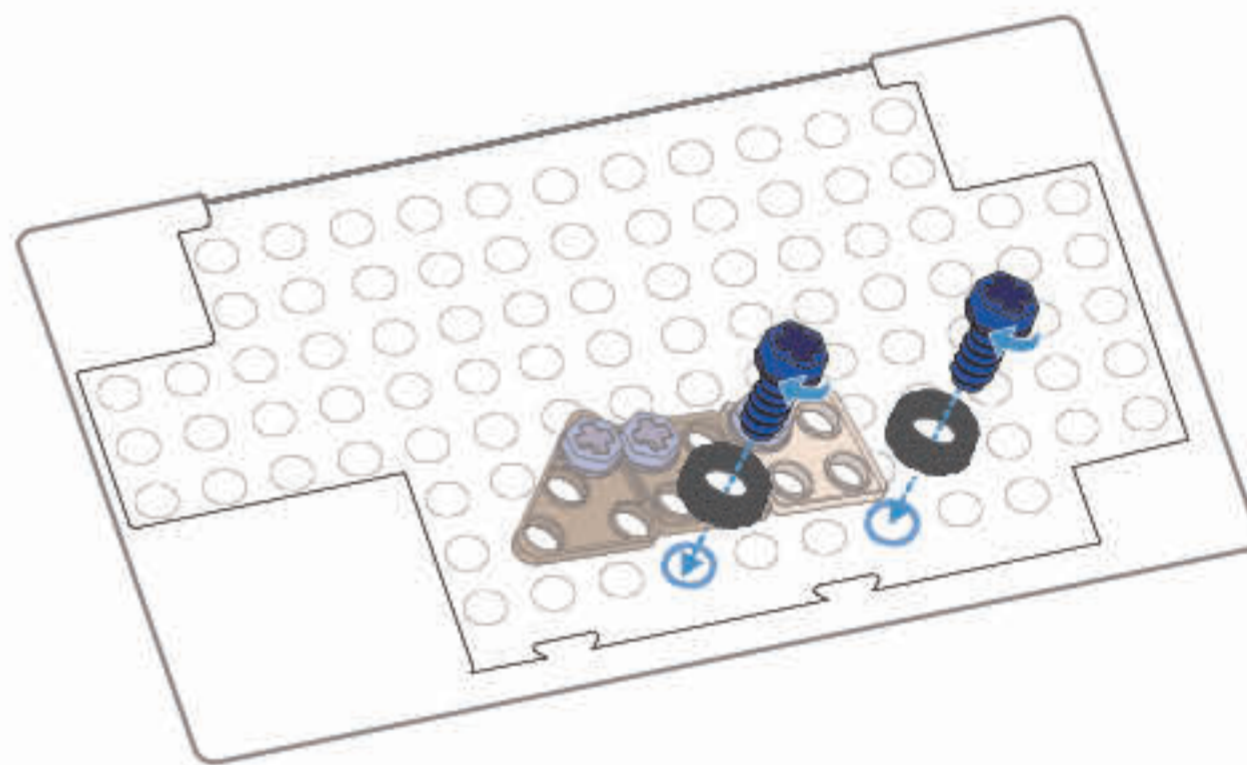
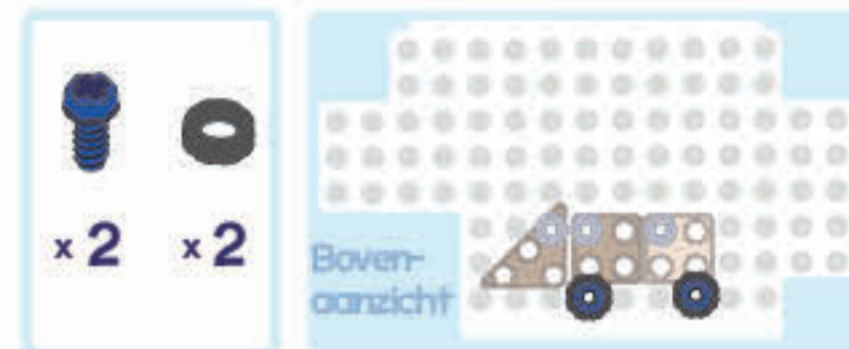

3

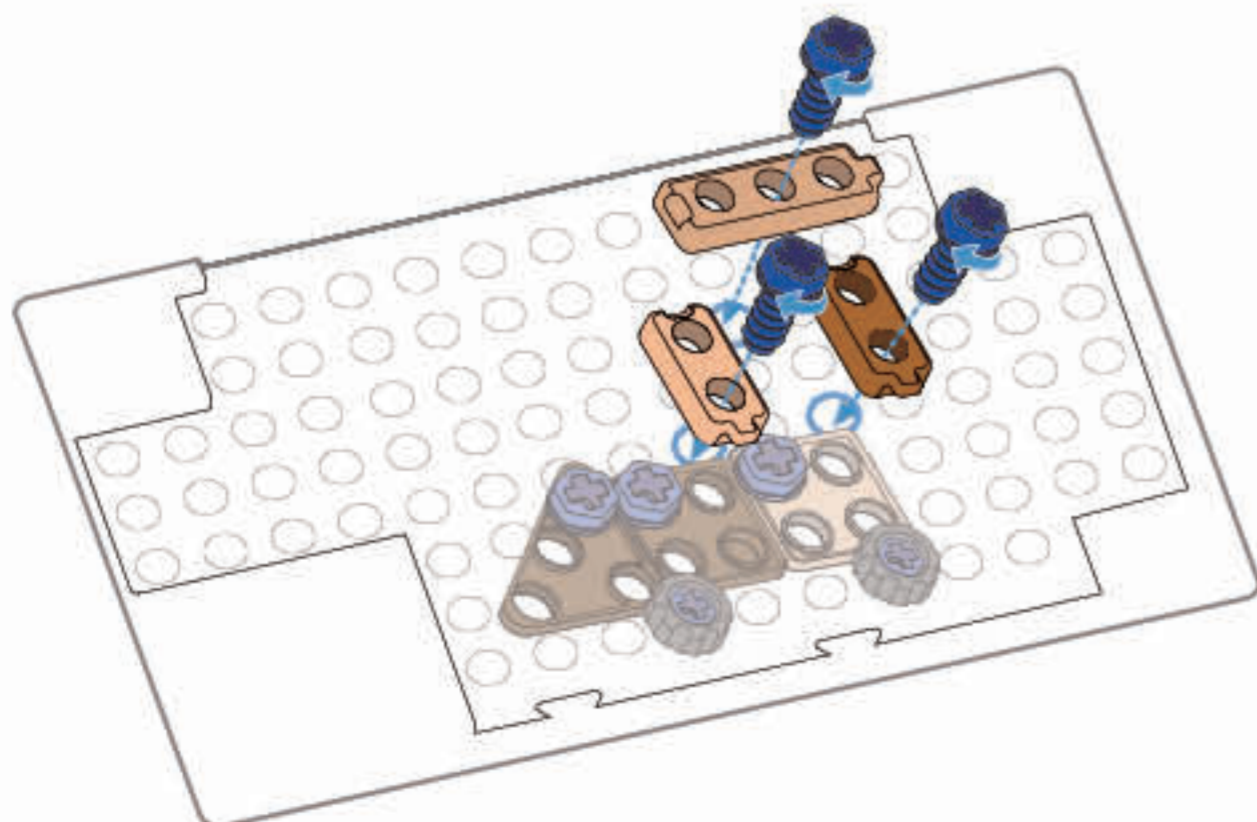

Goed werk!
Het is je gelukt!



8

007

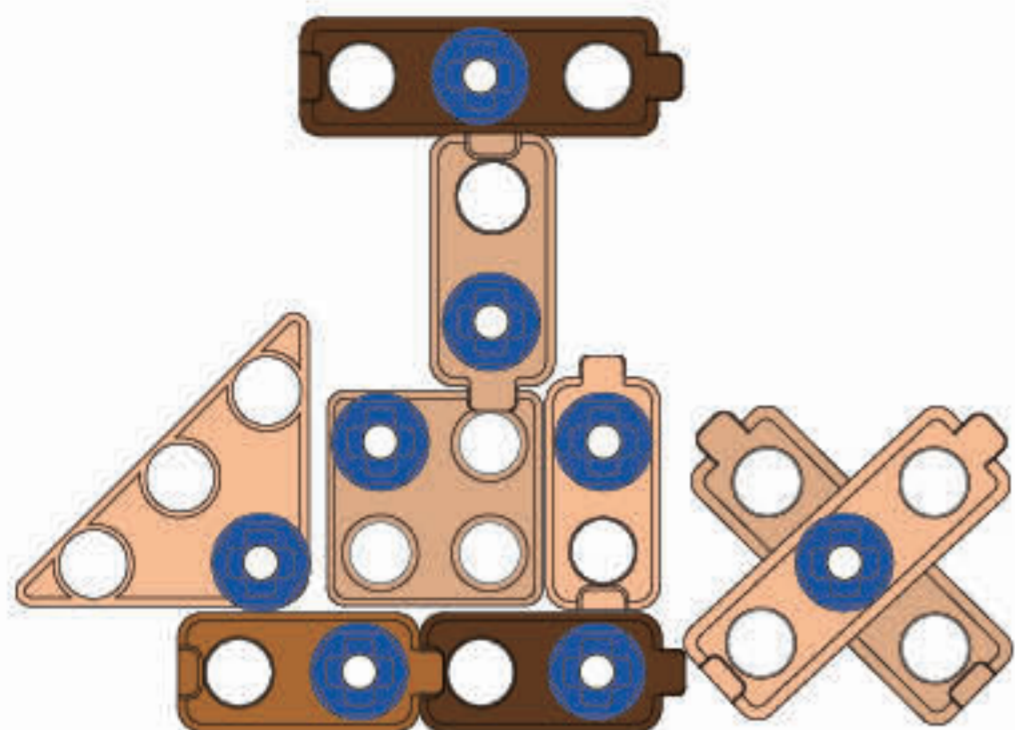
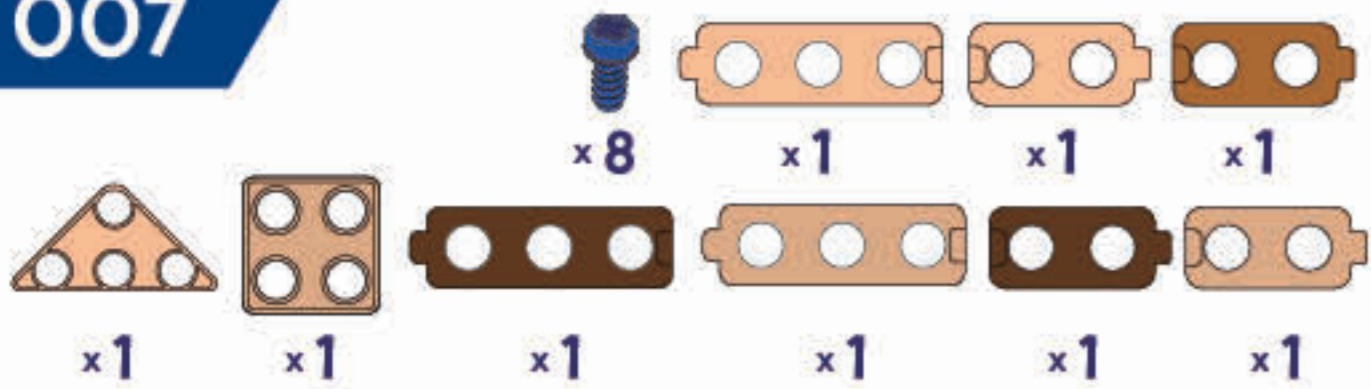

1

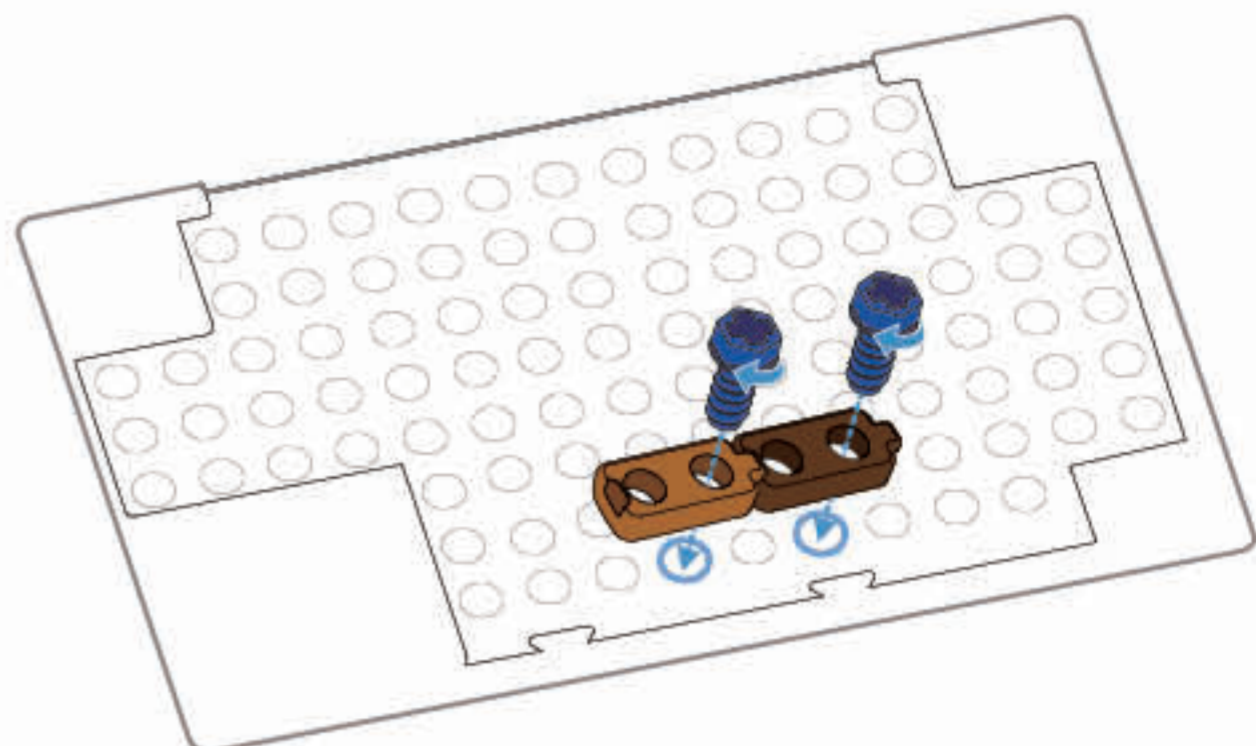
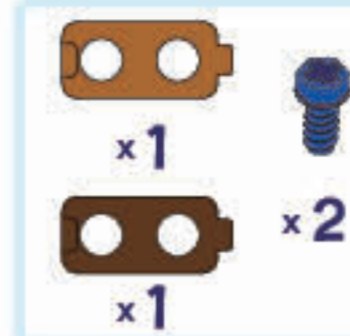

2

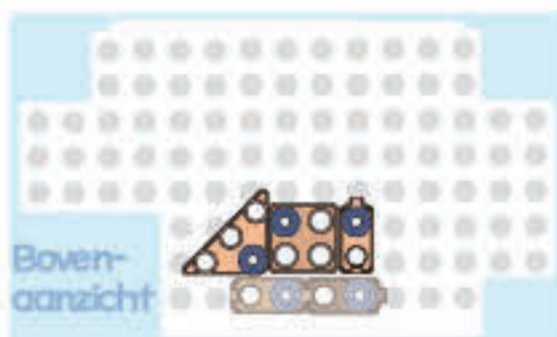
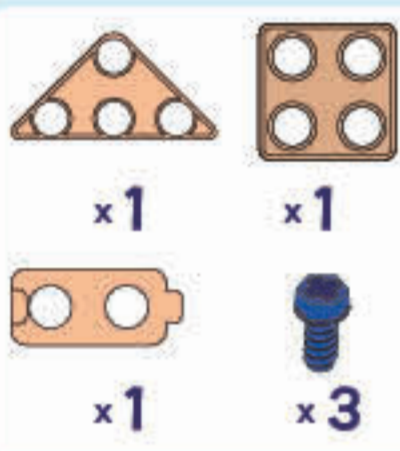

3

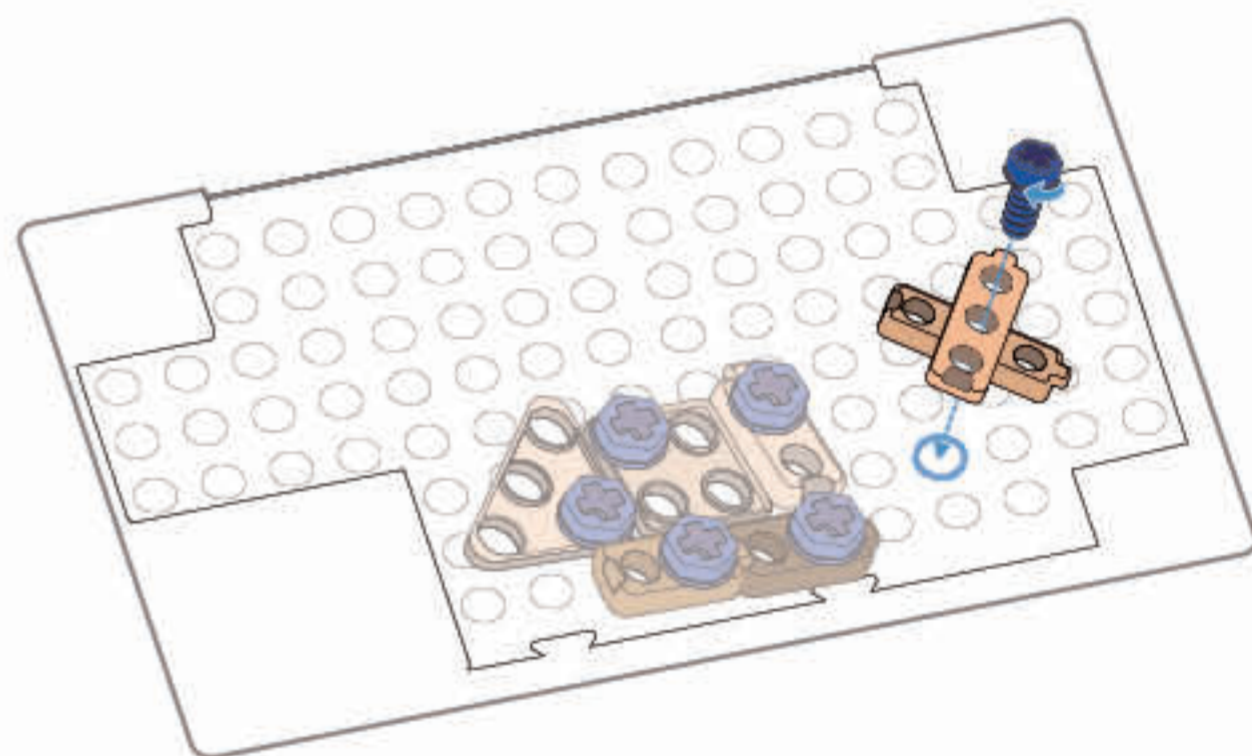
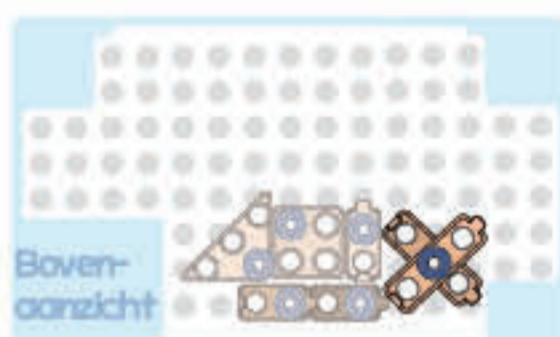
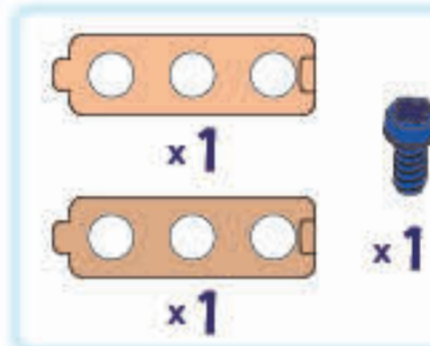

4

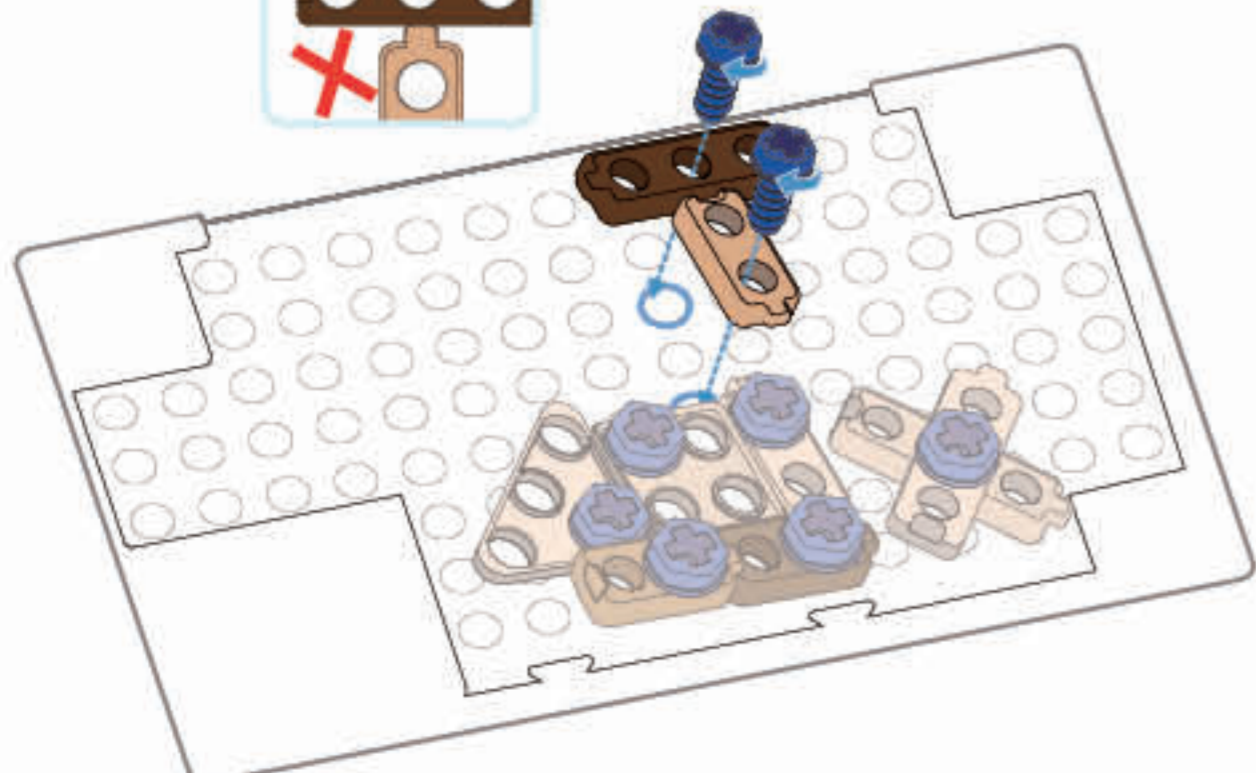
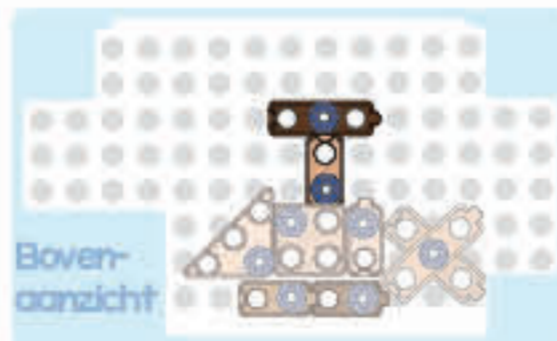
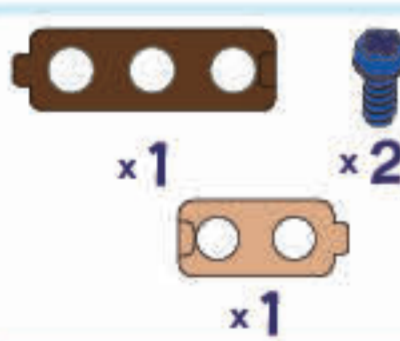







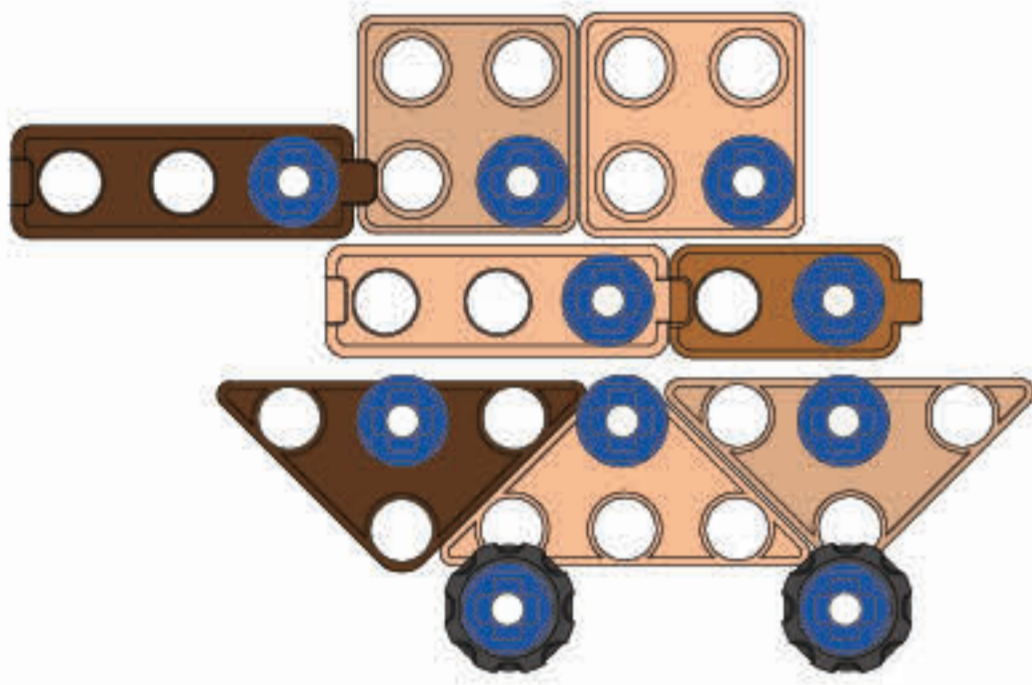



Goed werk!
Het is je gelukt!







008



-  x1
-  x1
-  x1
-  x1
-  x1
-  x1
-  x1
-  x1
-  x10
-  x2

1

-  x1
-  x1
-  x1
-  x3

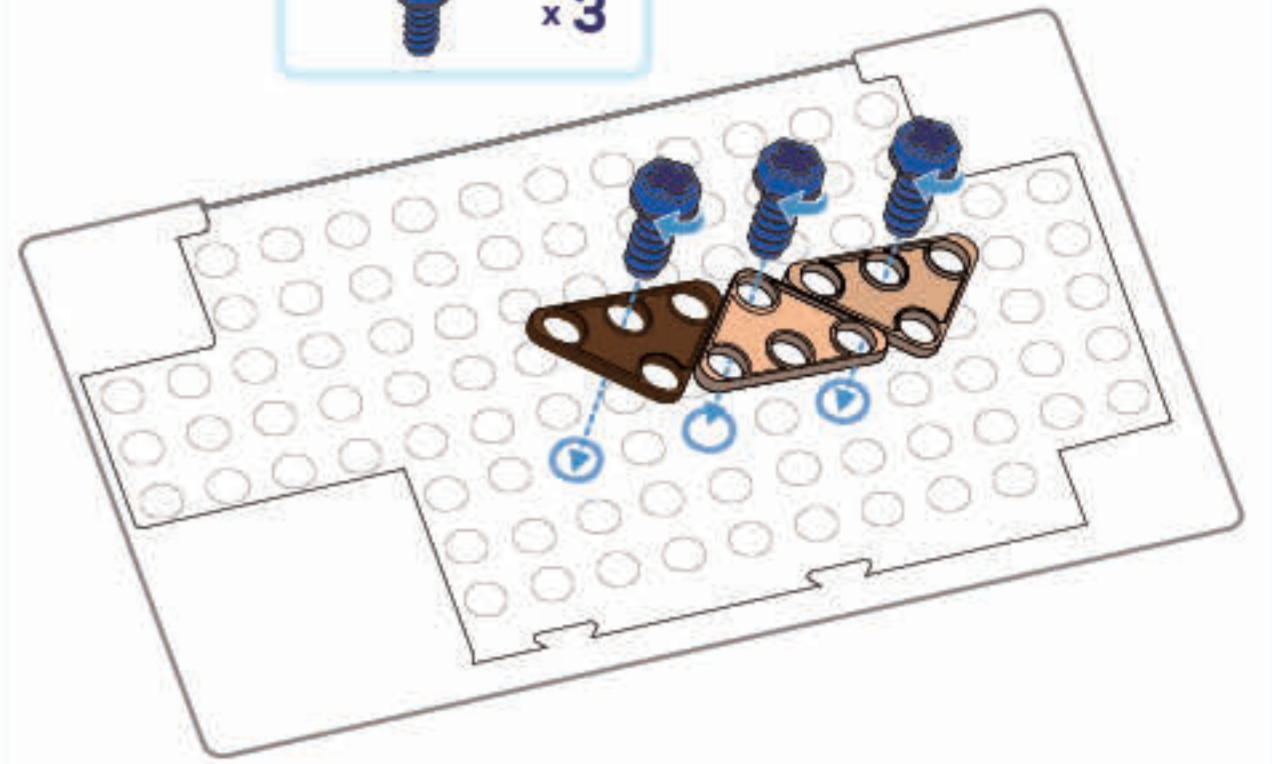
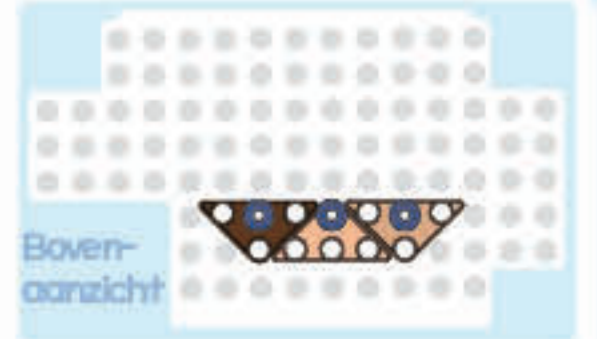

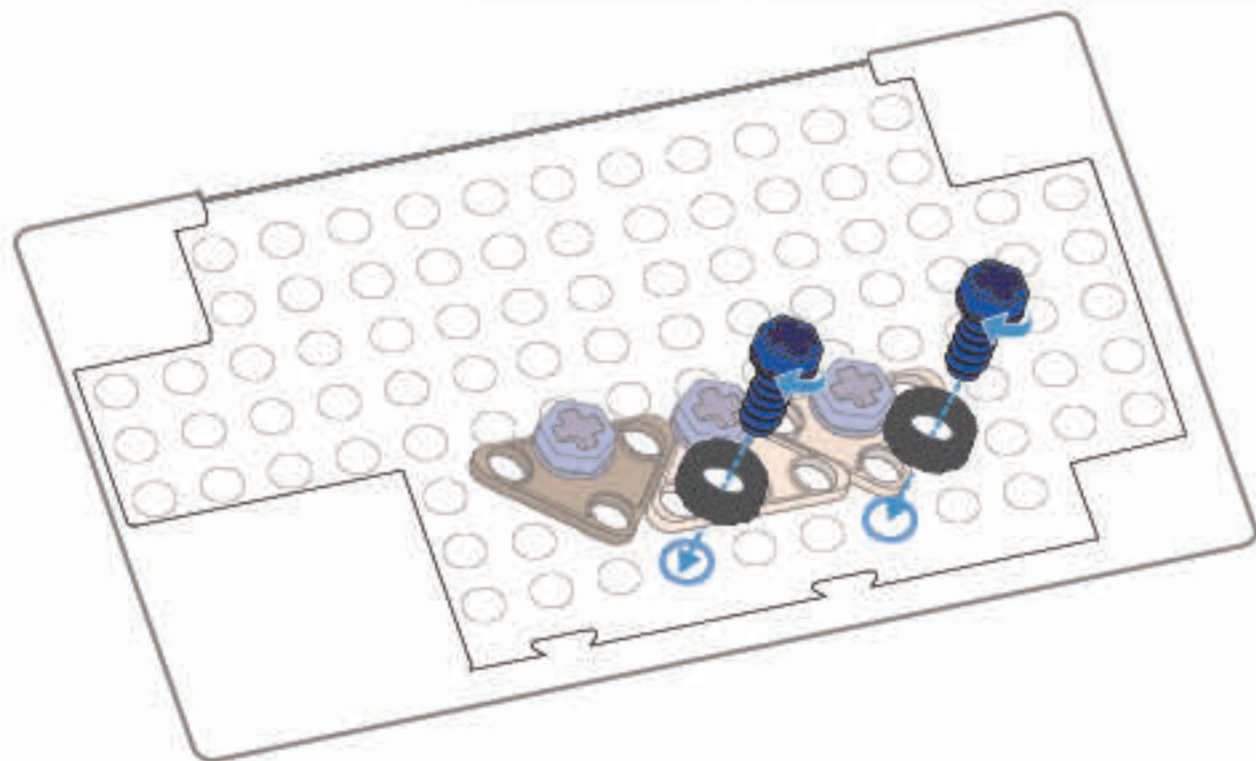
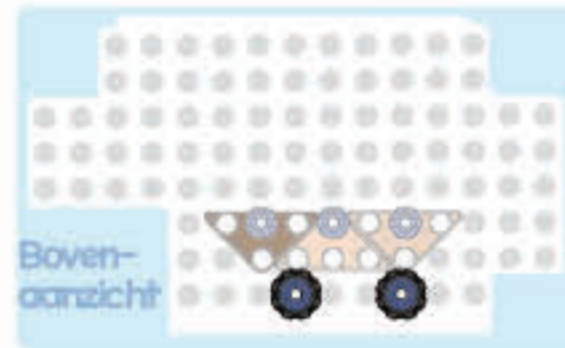

2

-  x2
-  x2





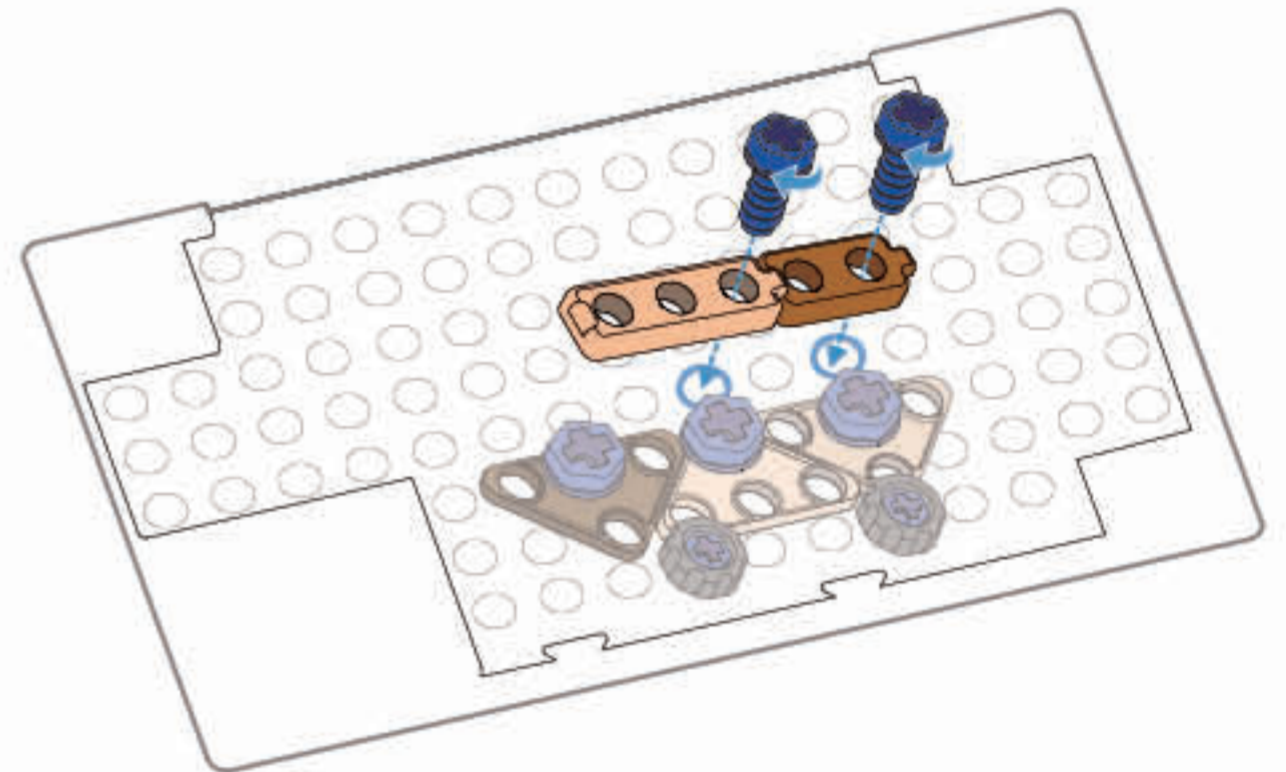
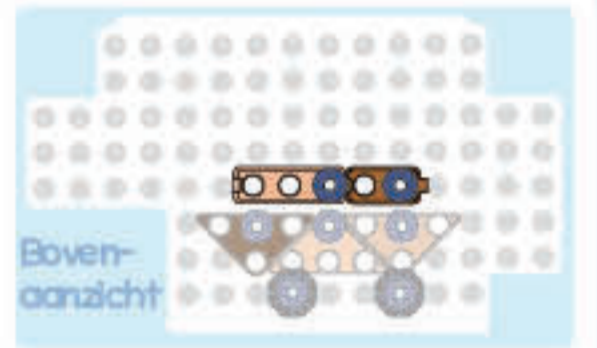

3

-  x1
-  x1
-  x2



4

-  x1
-  x3
-  x1
-  x1

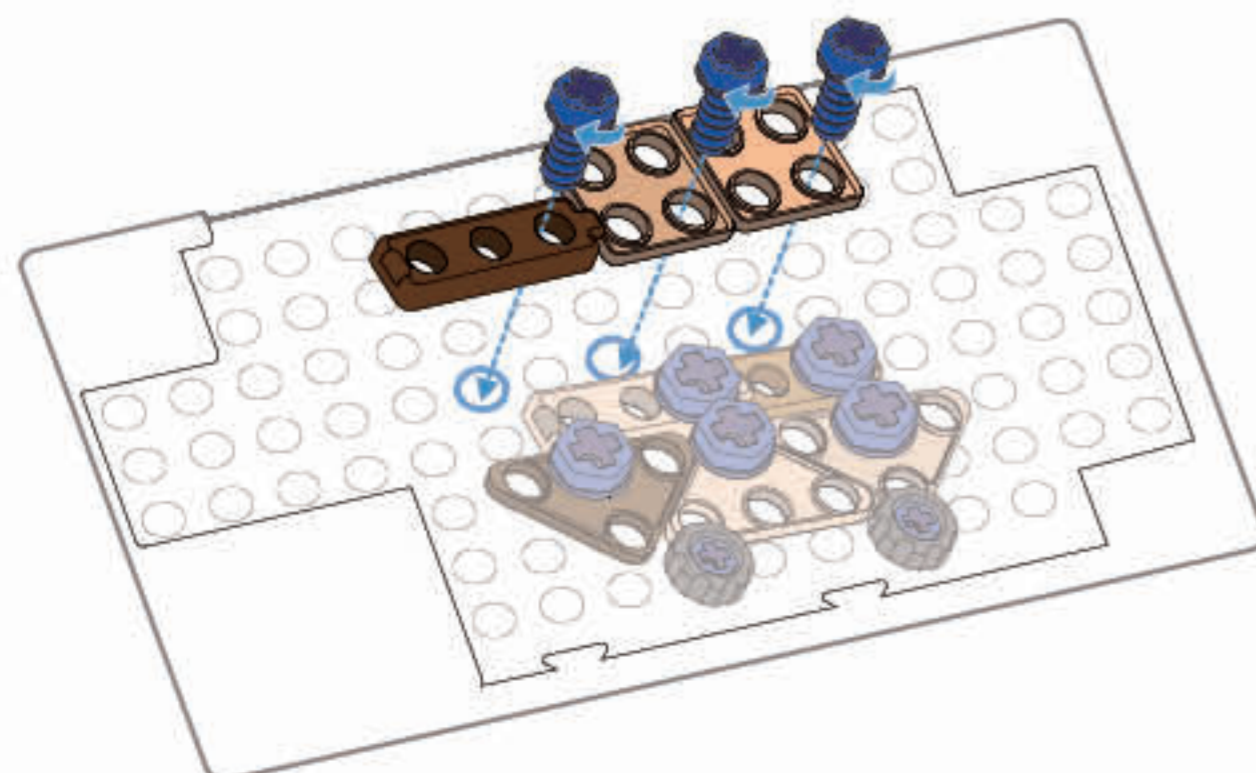
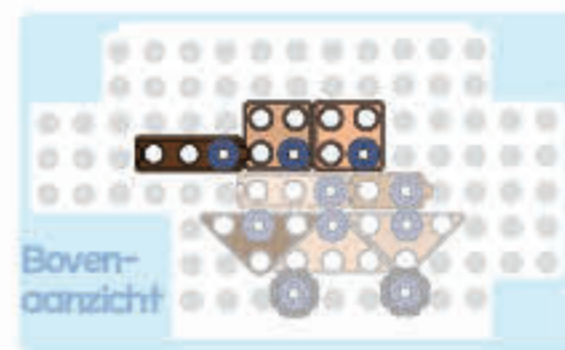

Goed werk!
Het is je gelukt!



009

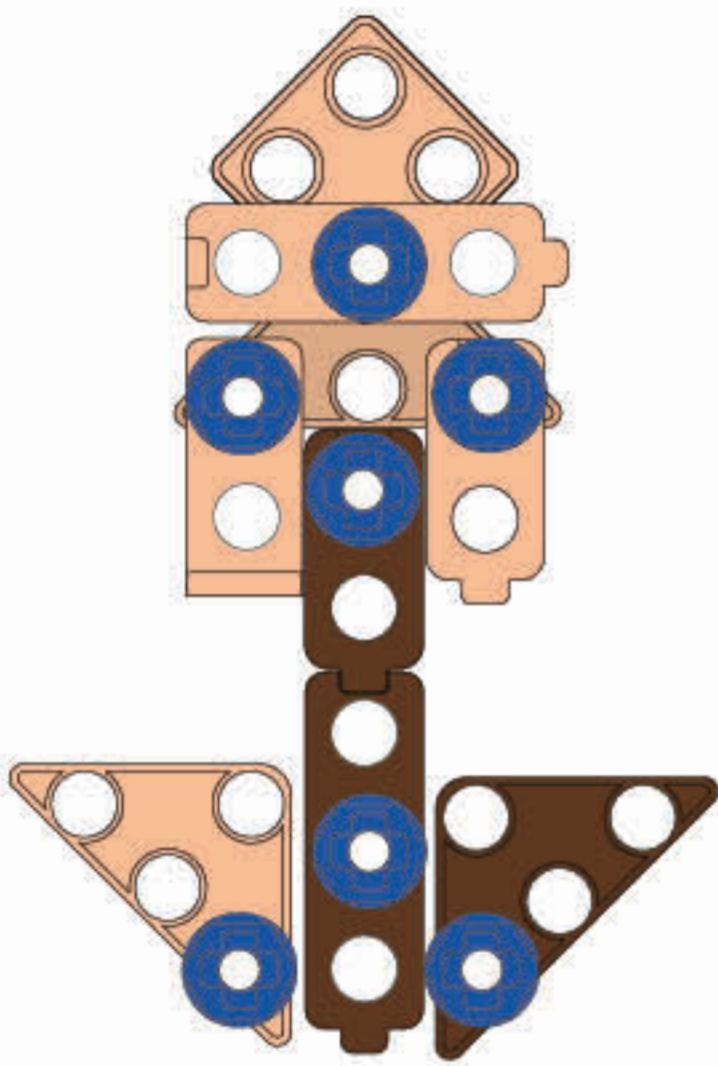
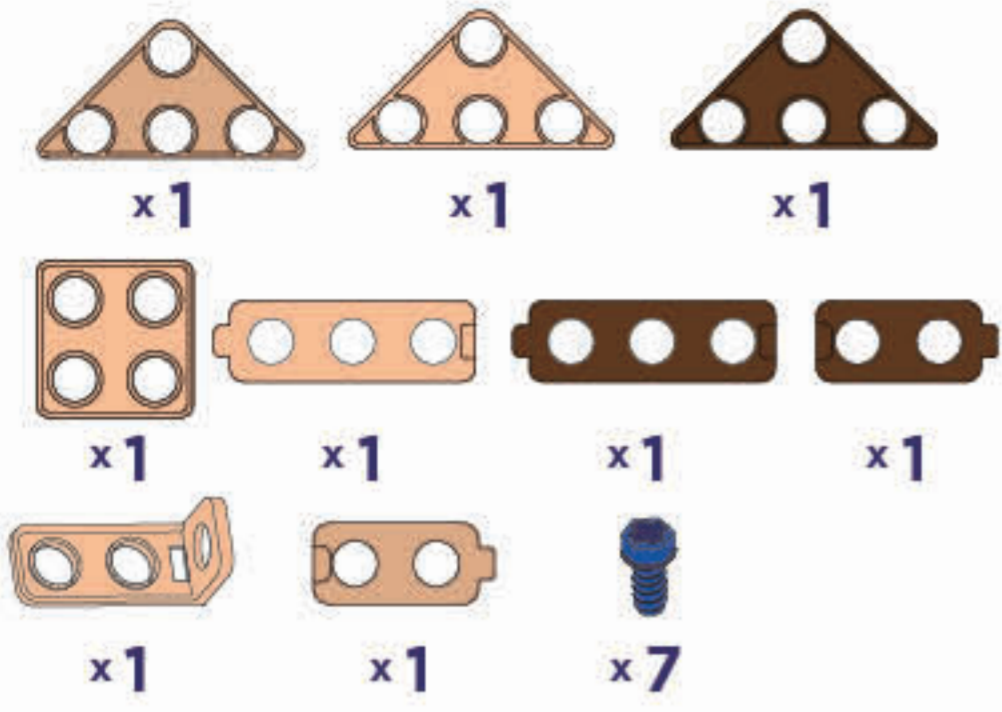

1

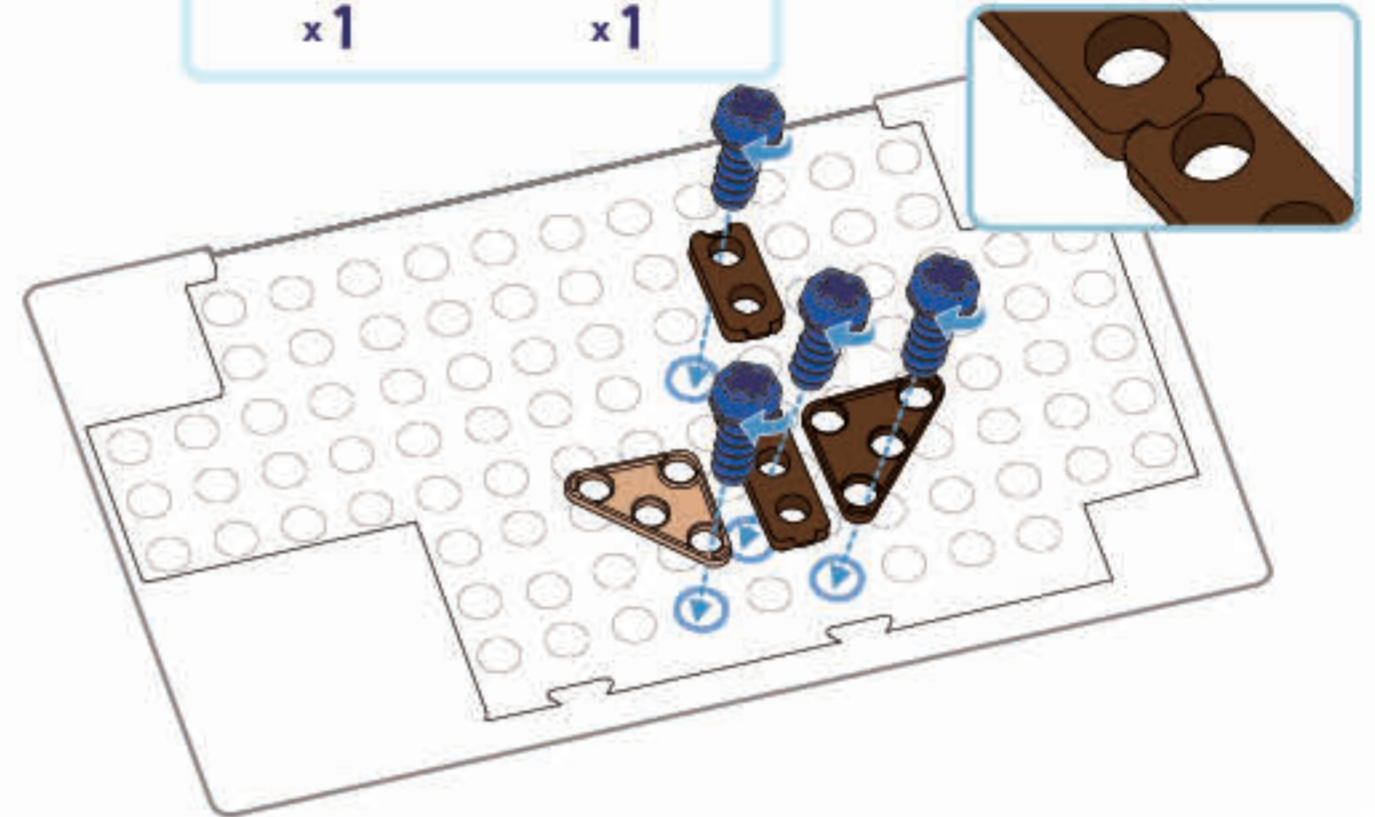
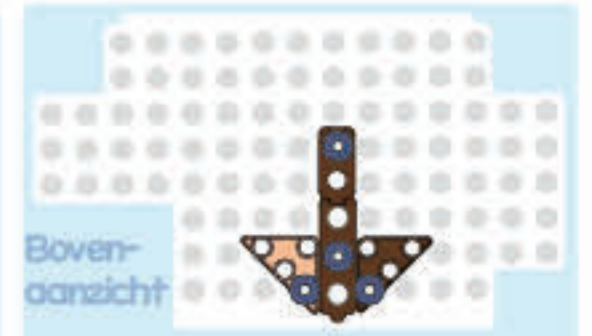
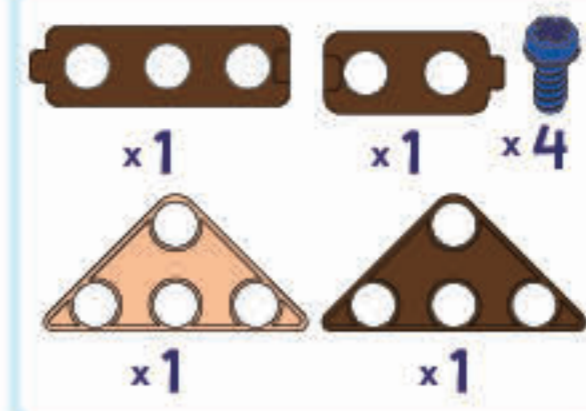

2

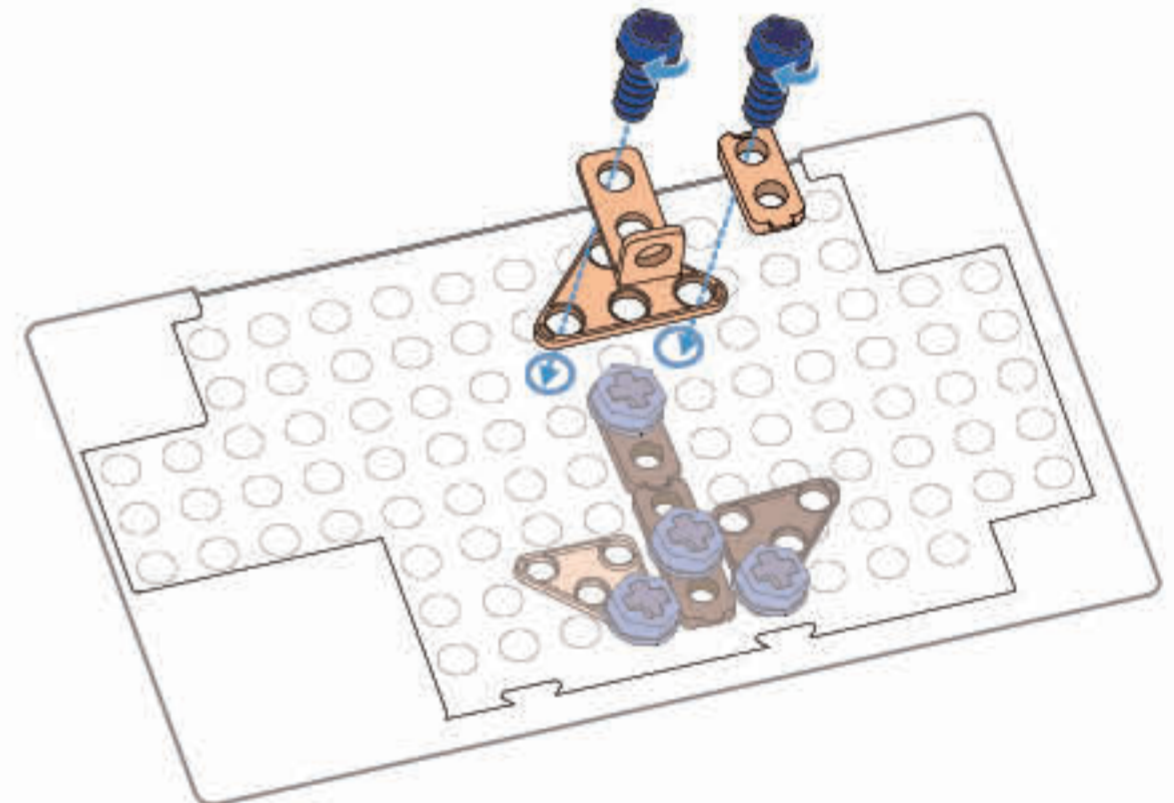
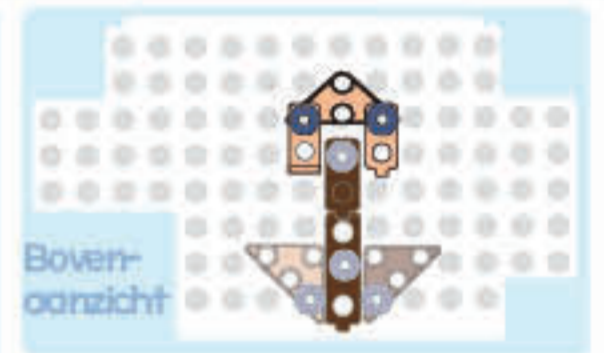
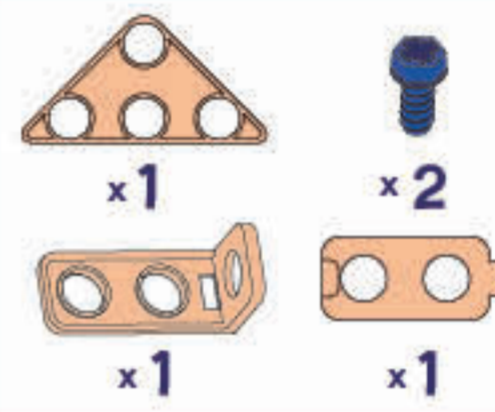

3

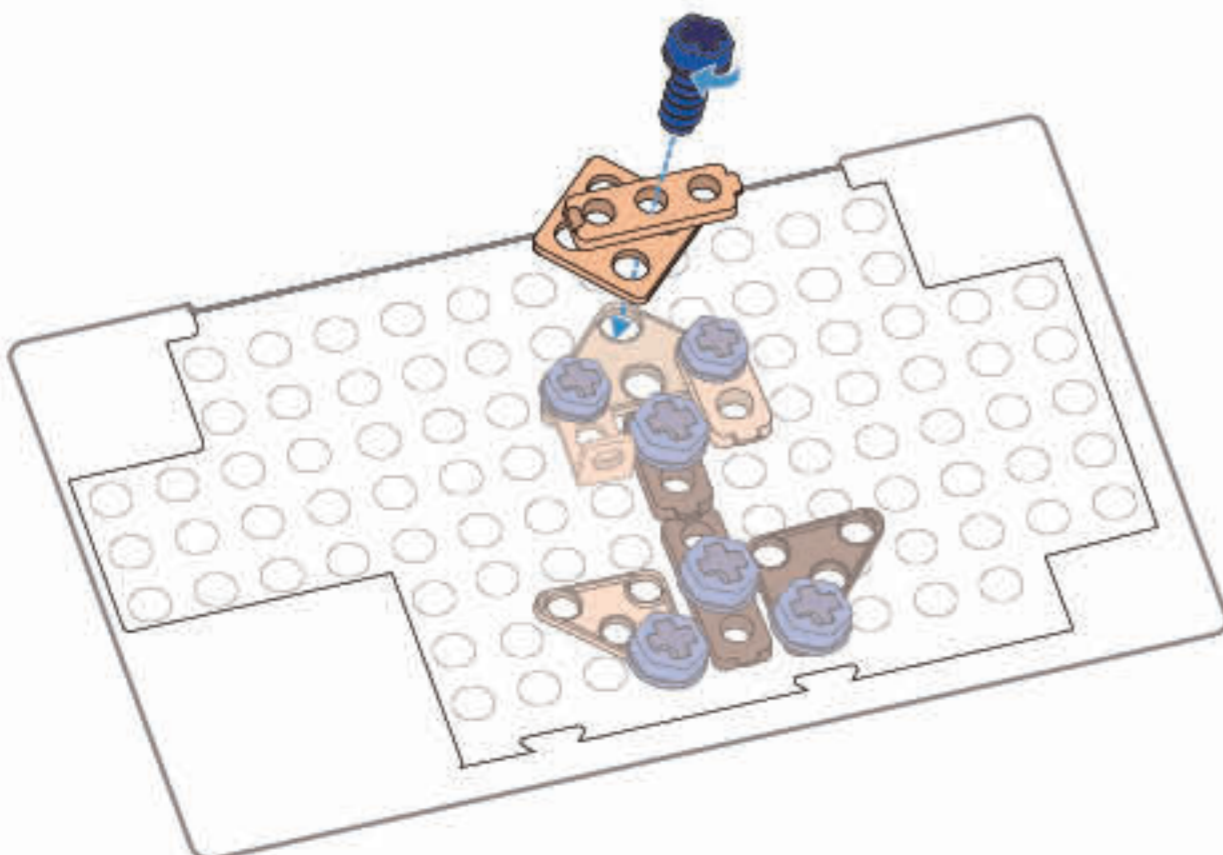
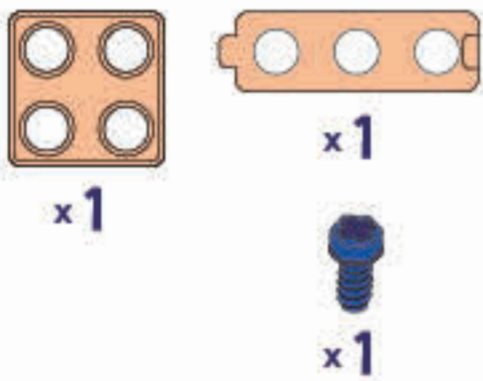

Goed werk!
Het is je gelukt!

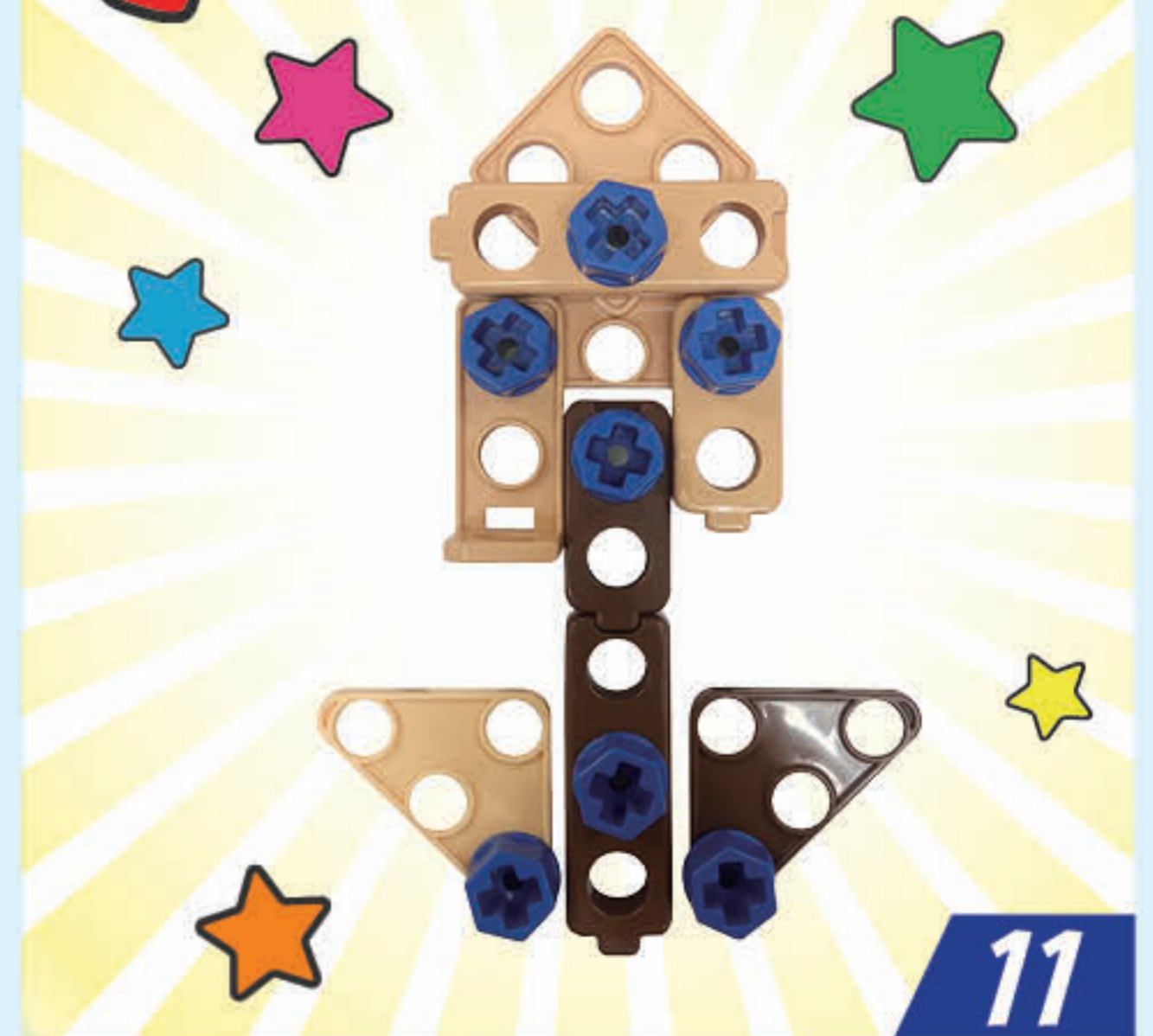

11

010

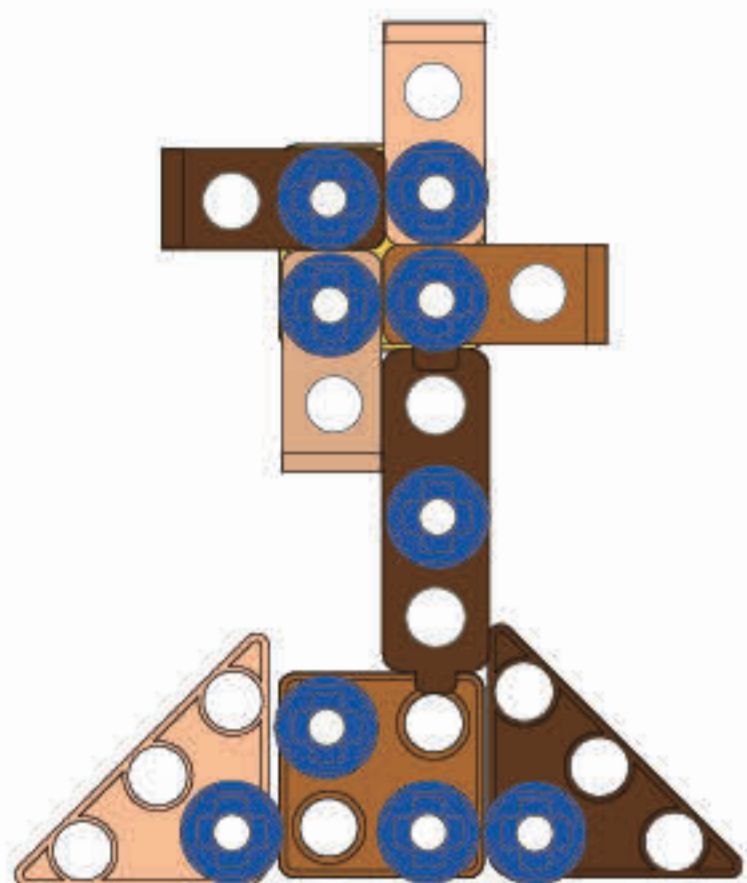
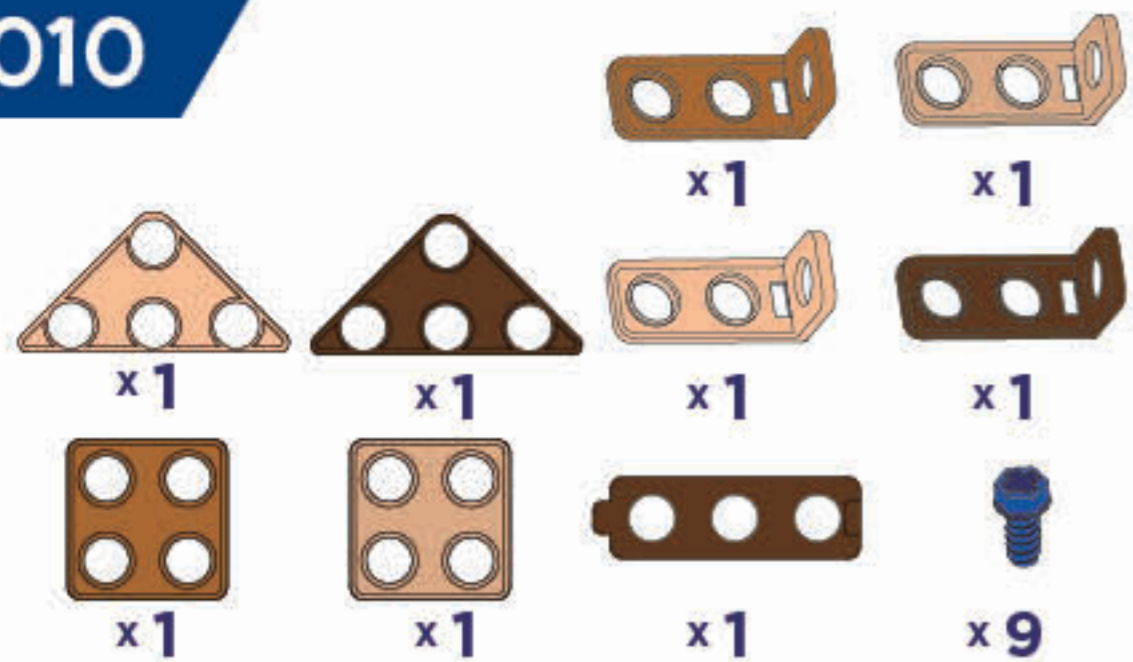

1

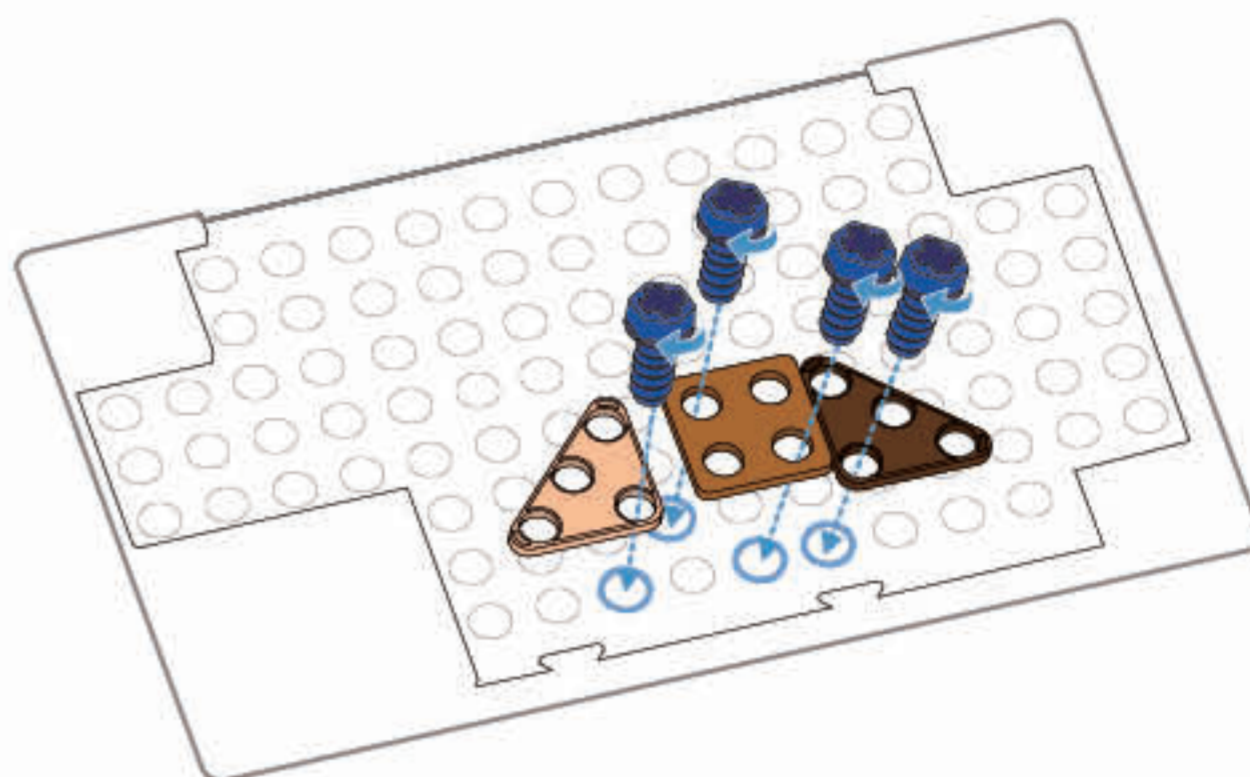
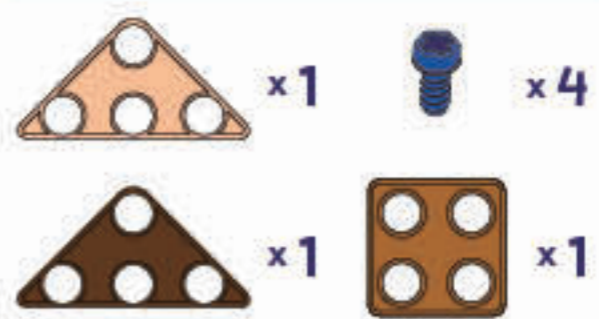

2

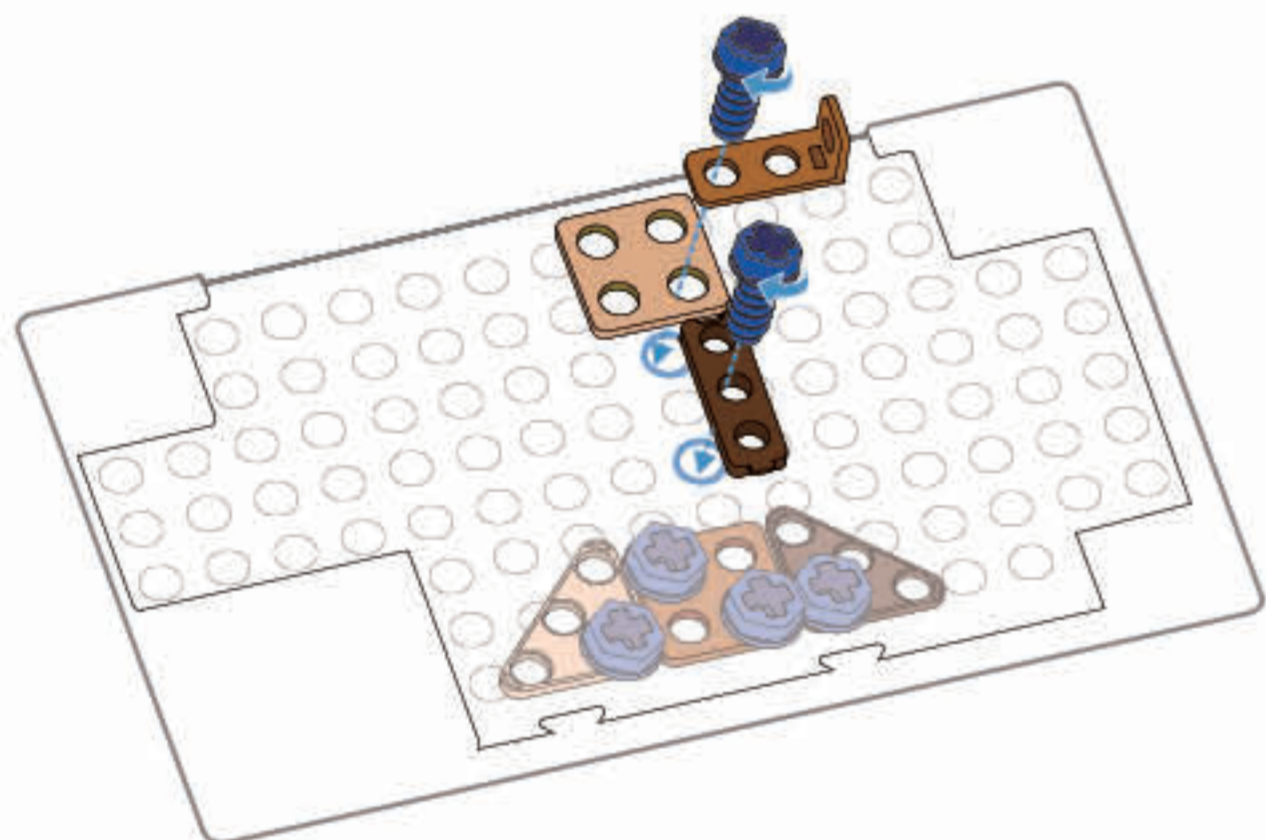
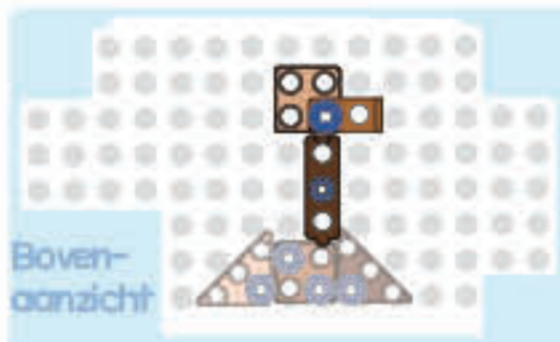
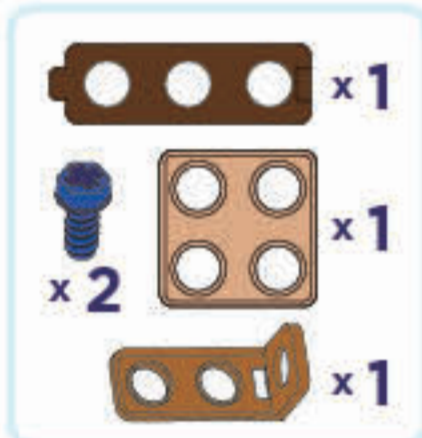

3

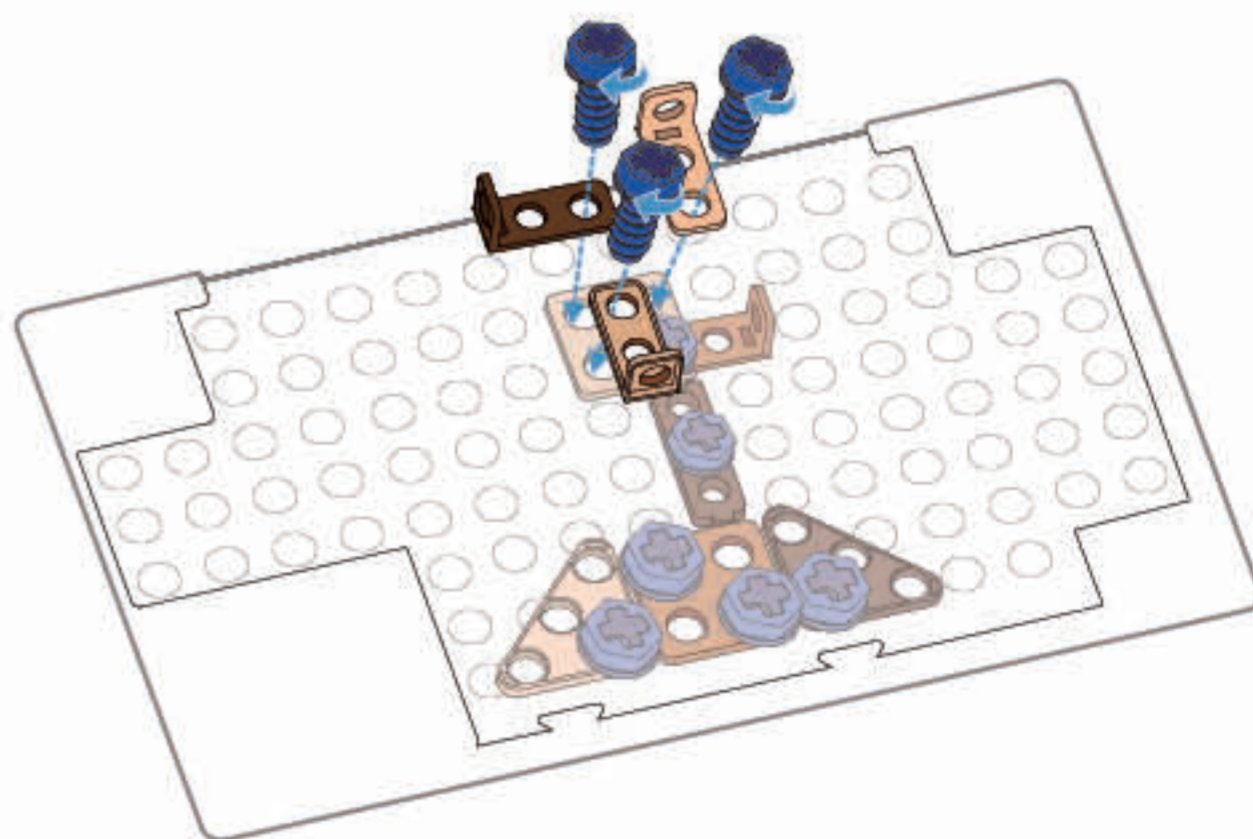
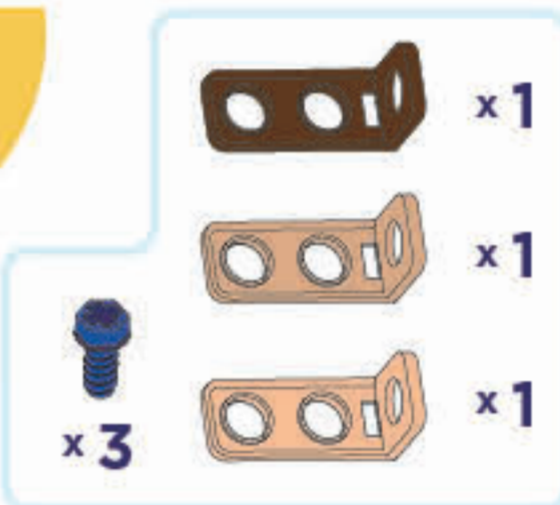

Goed werk!
Het is je gelukt!



Niveau 3

011

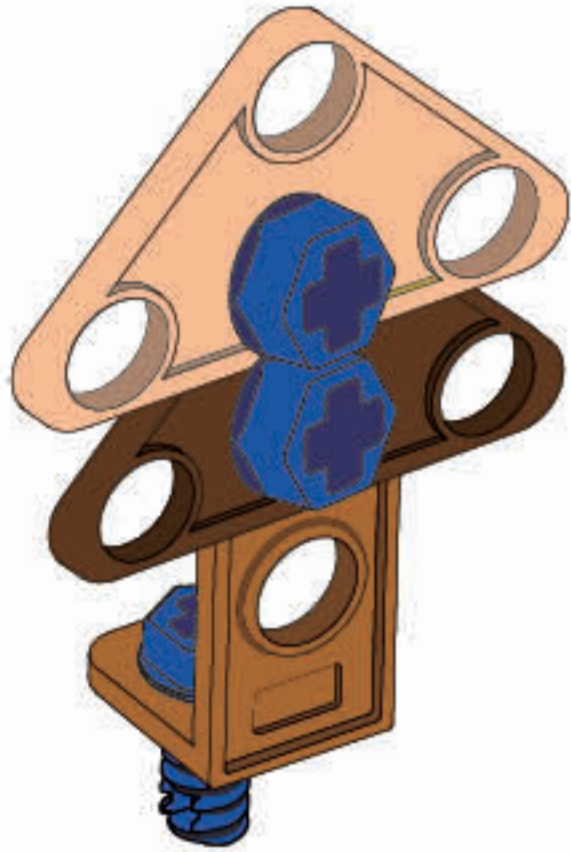
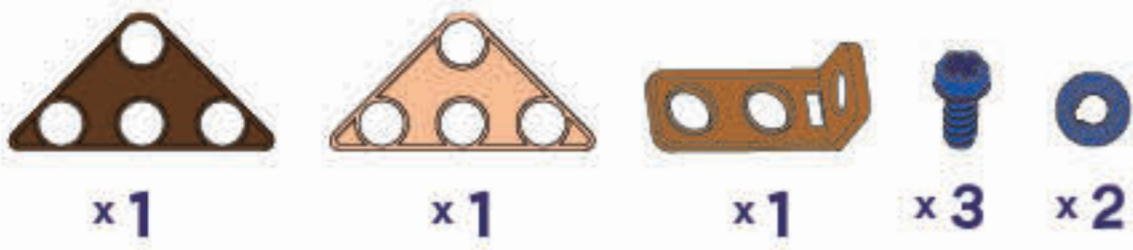

1

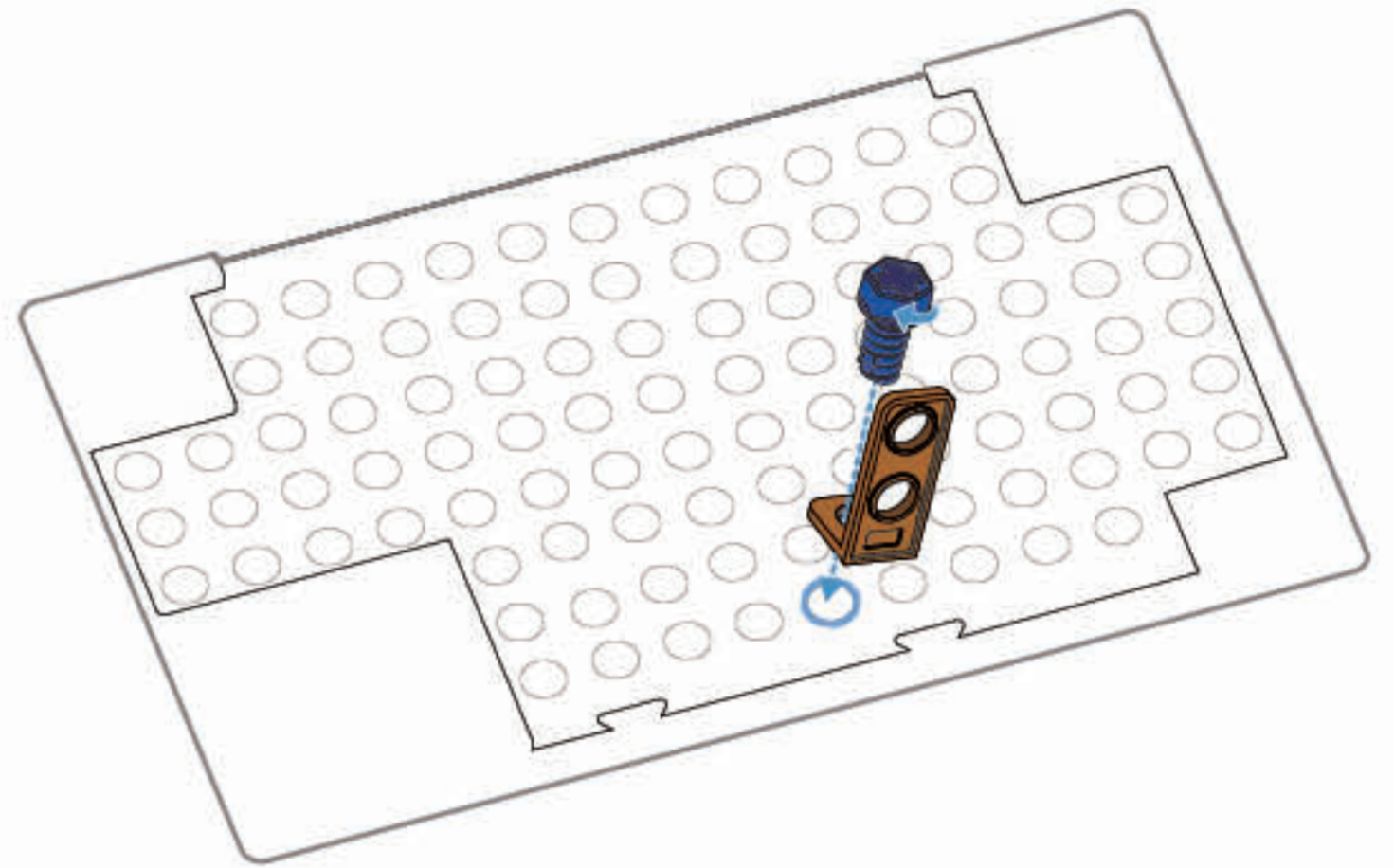

2

Achterkant

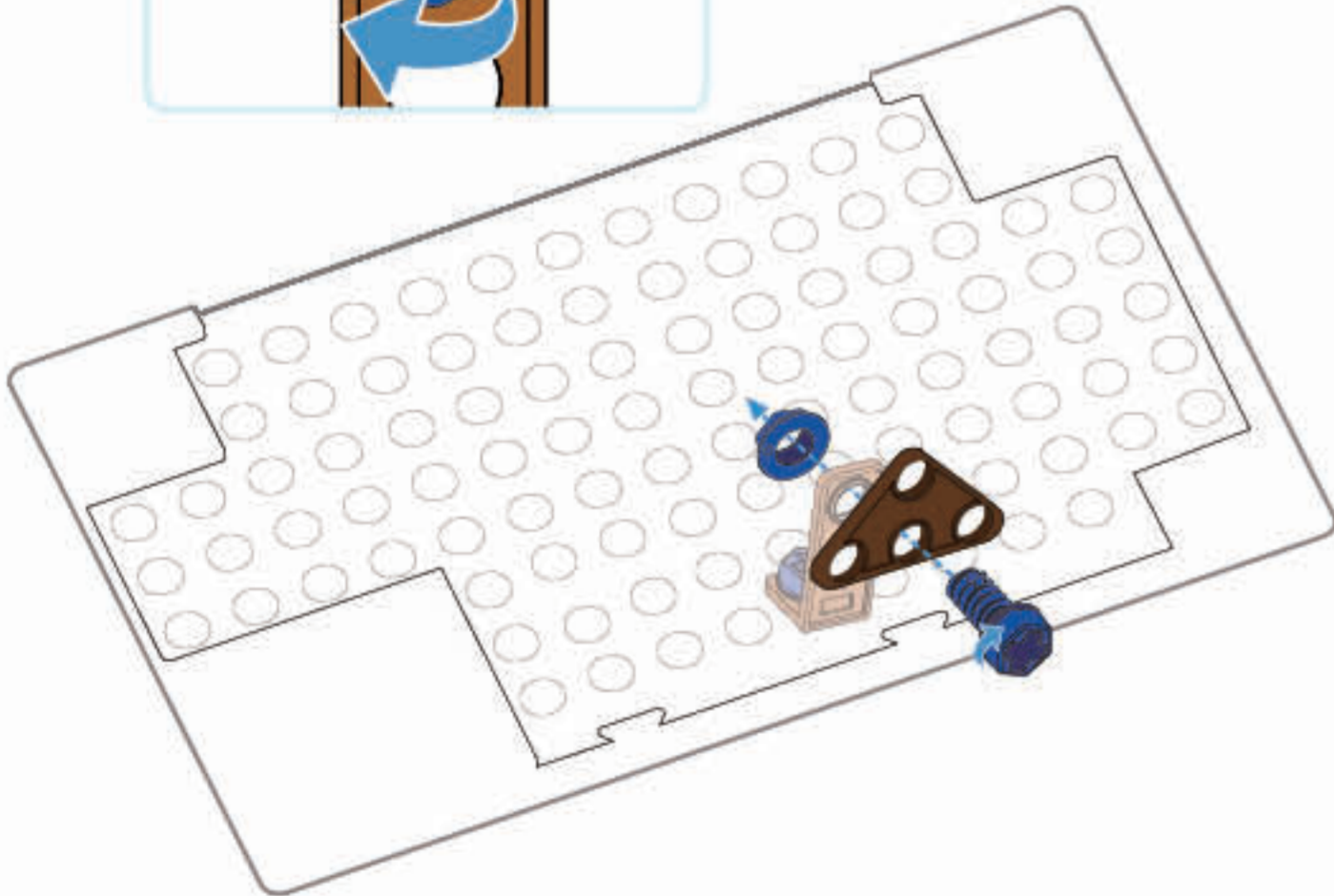

3

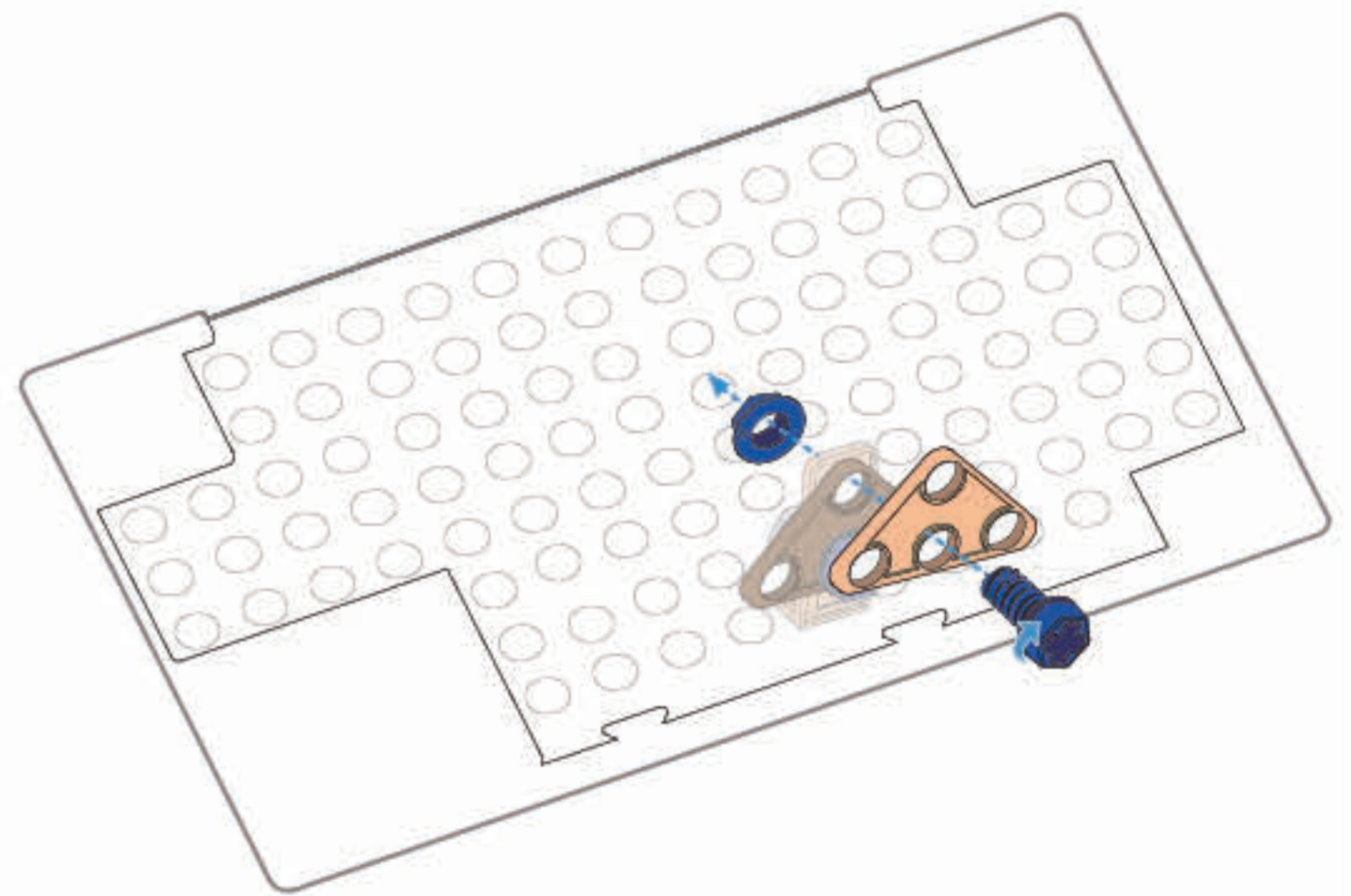
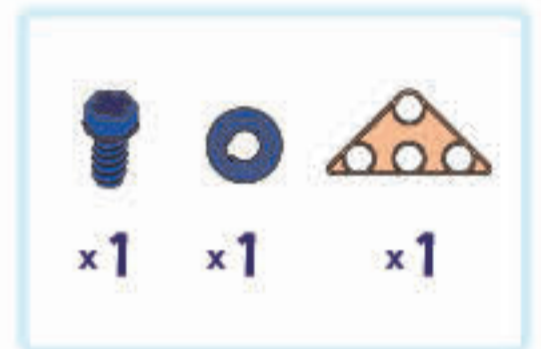

Goed werk!
Het is je gelukt!



012

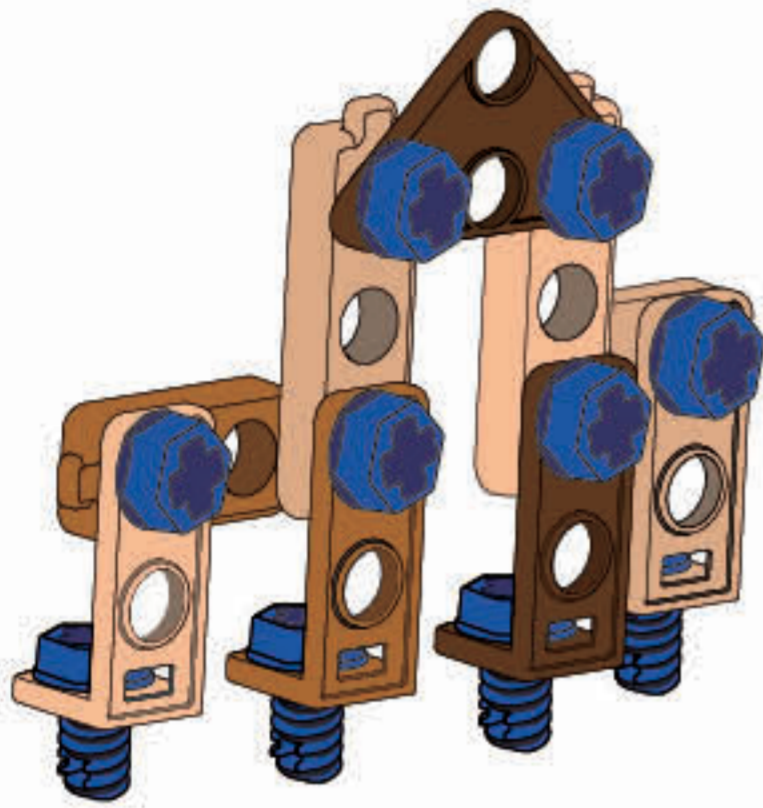
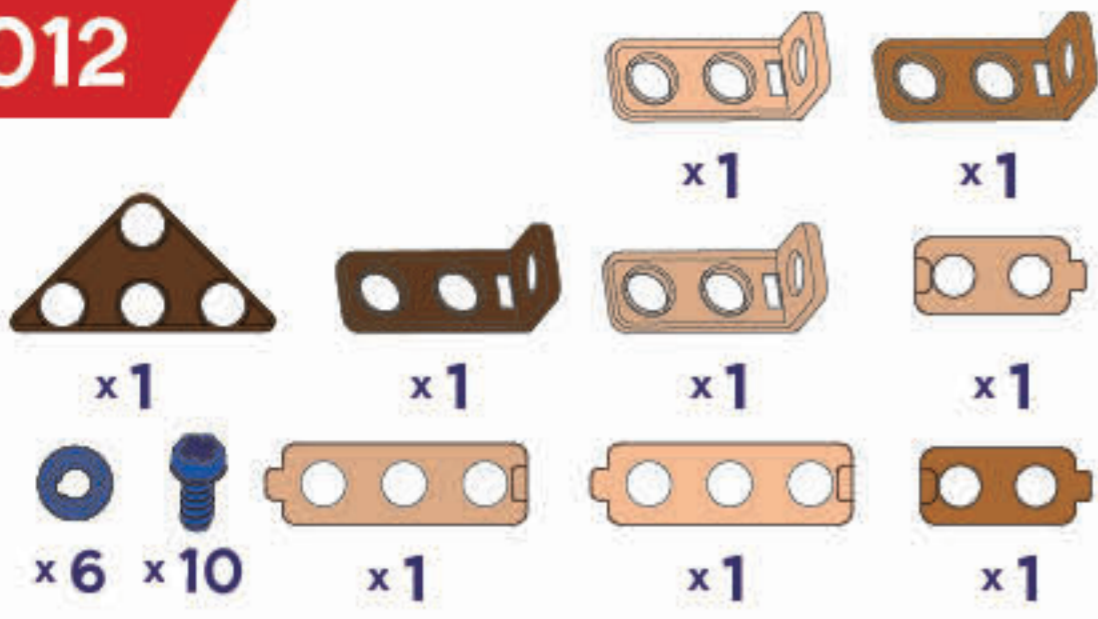

1

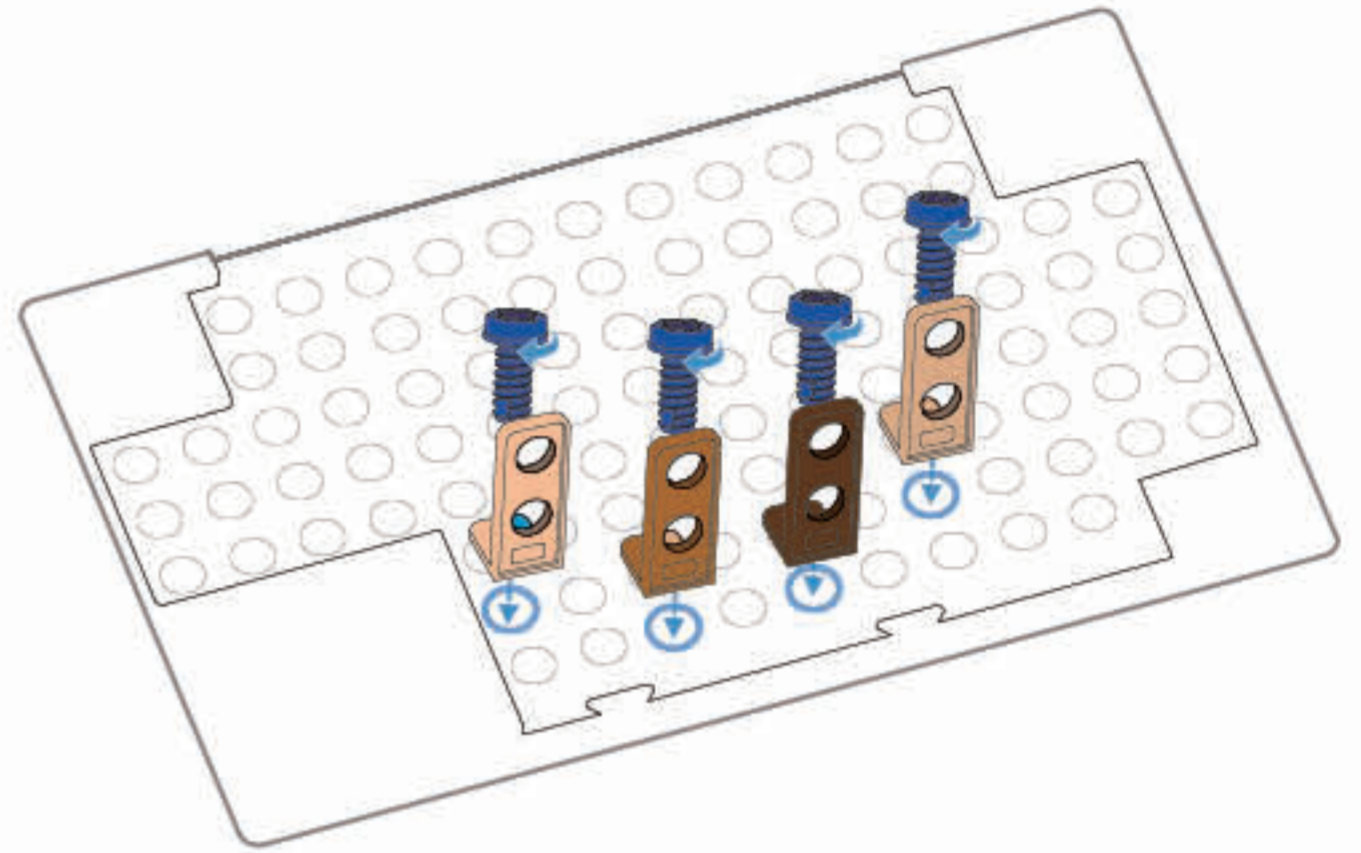
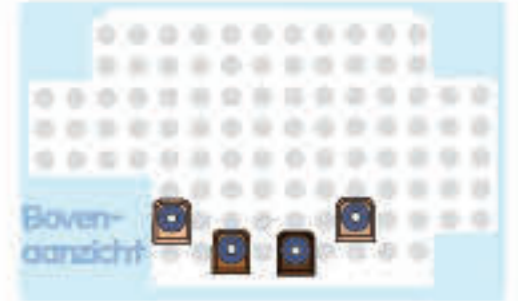
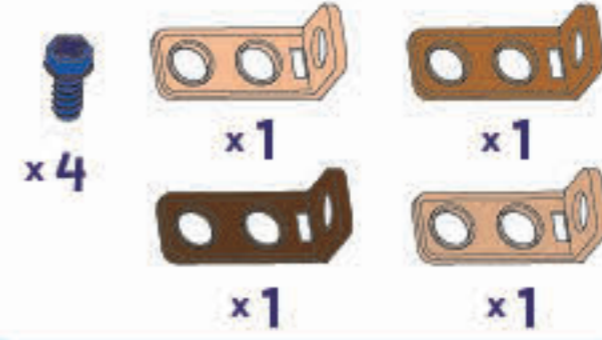

2

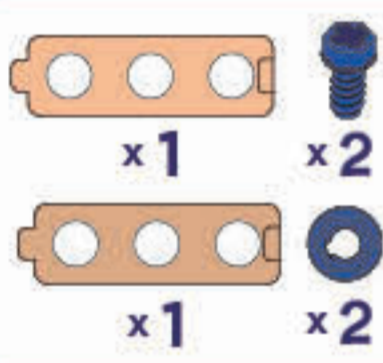

Achterkant

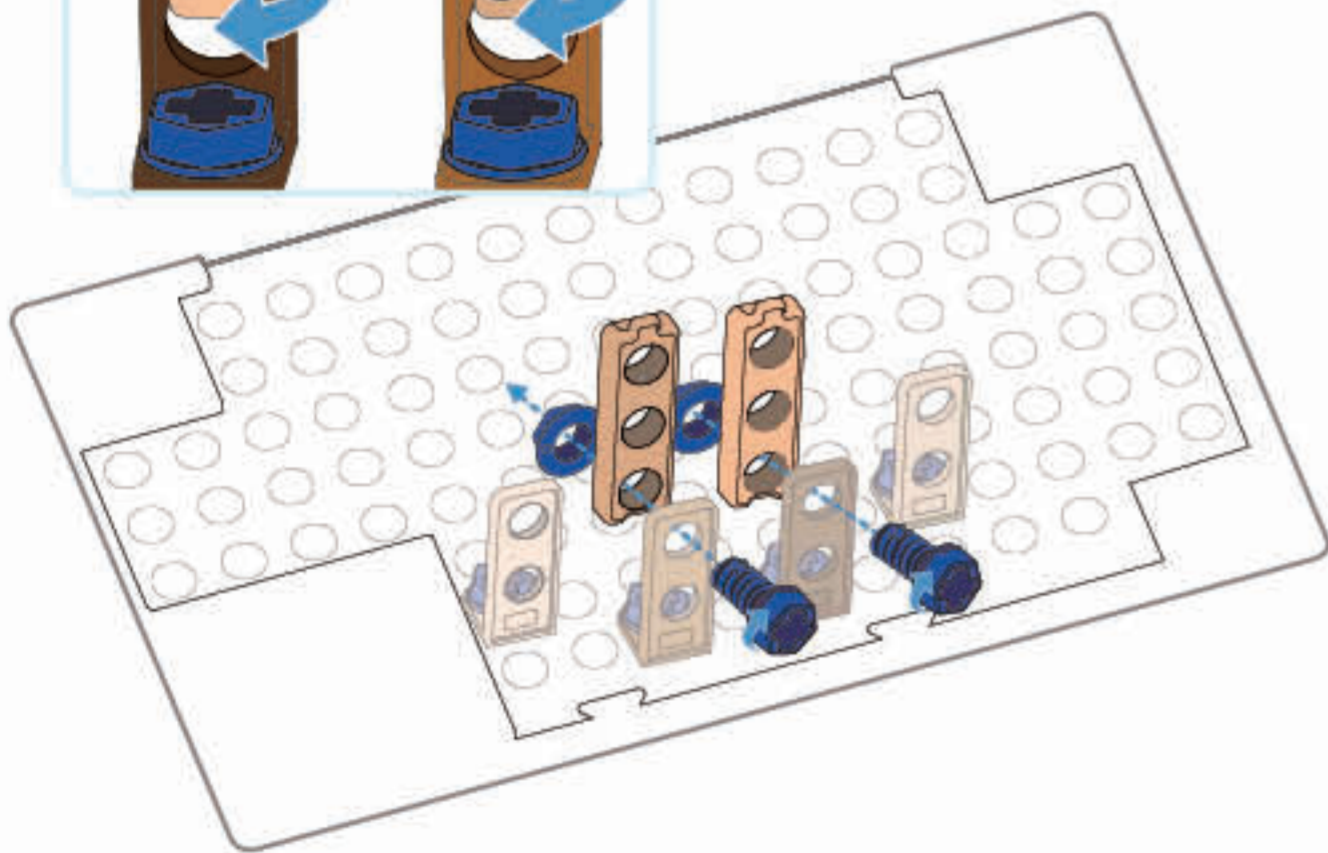
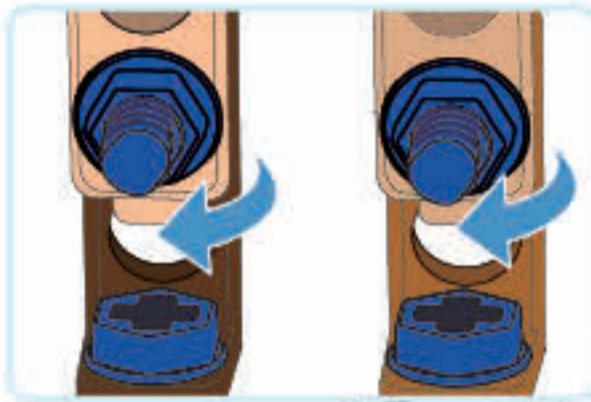

3

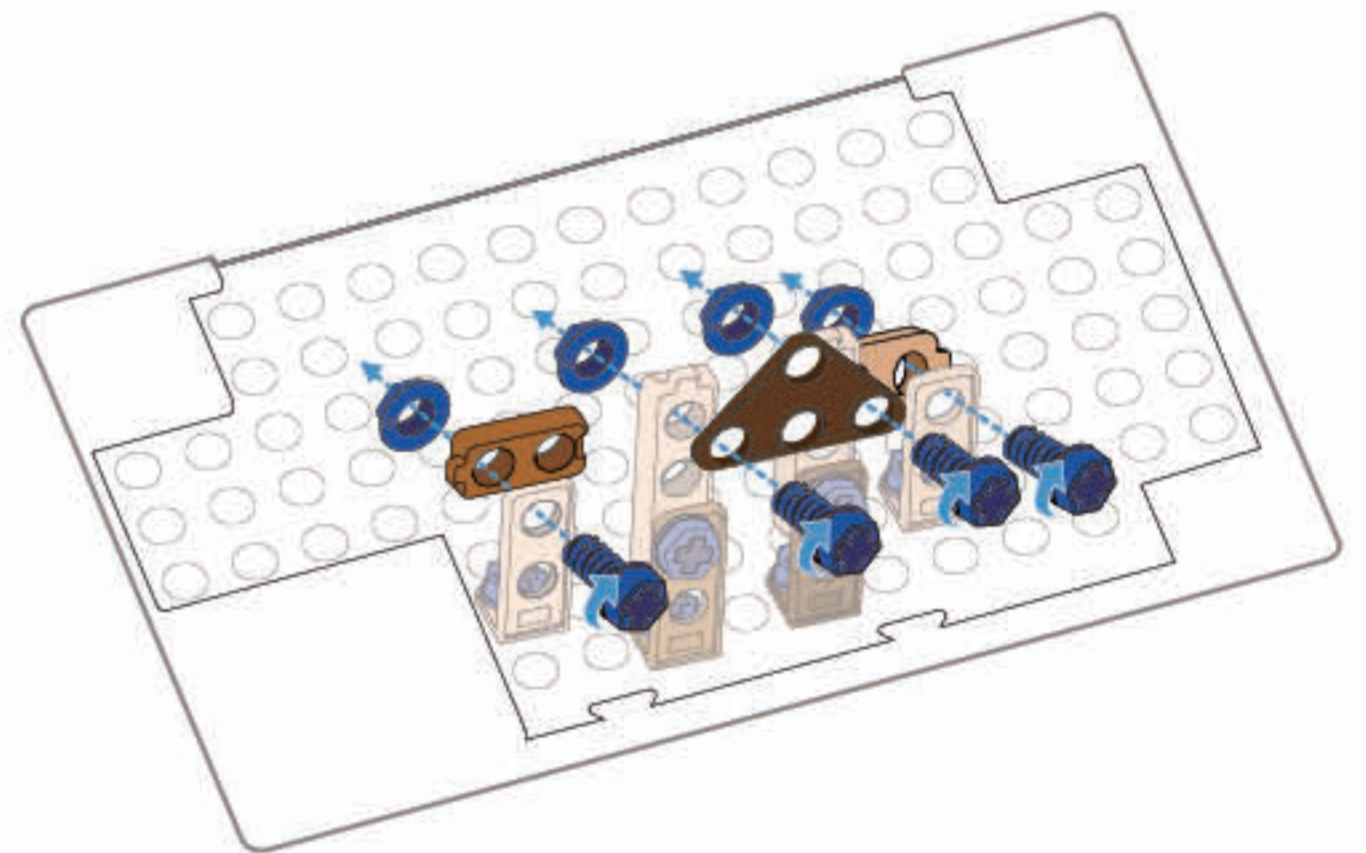
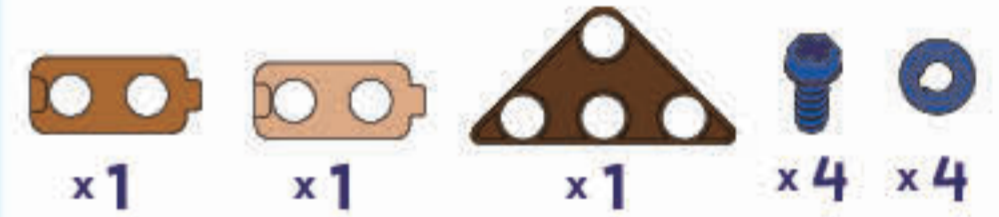

Goed werk!
Het is je gelukt!



013

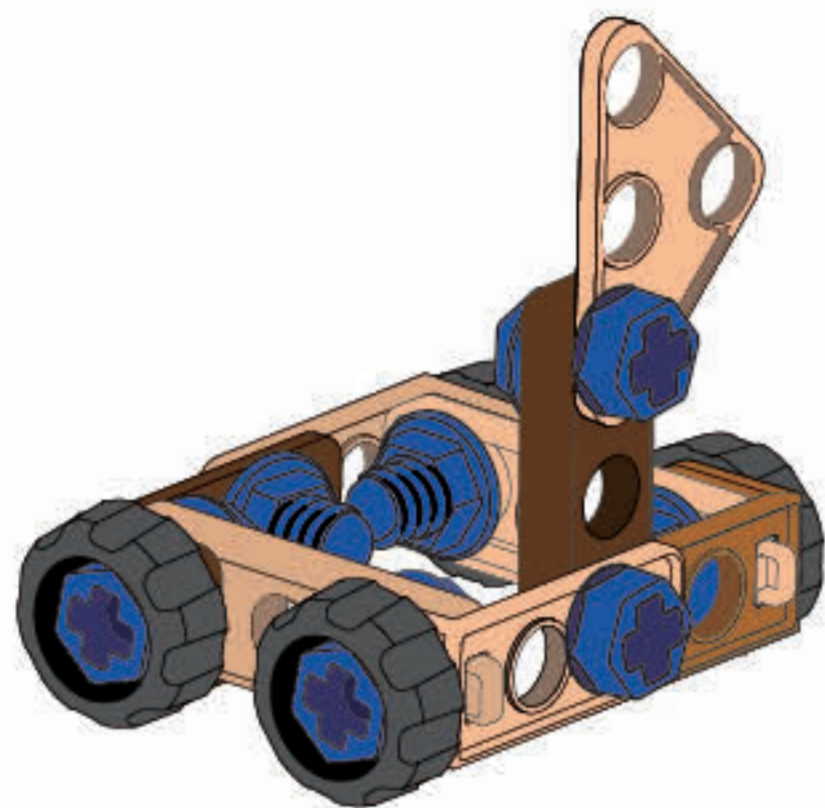

1

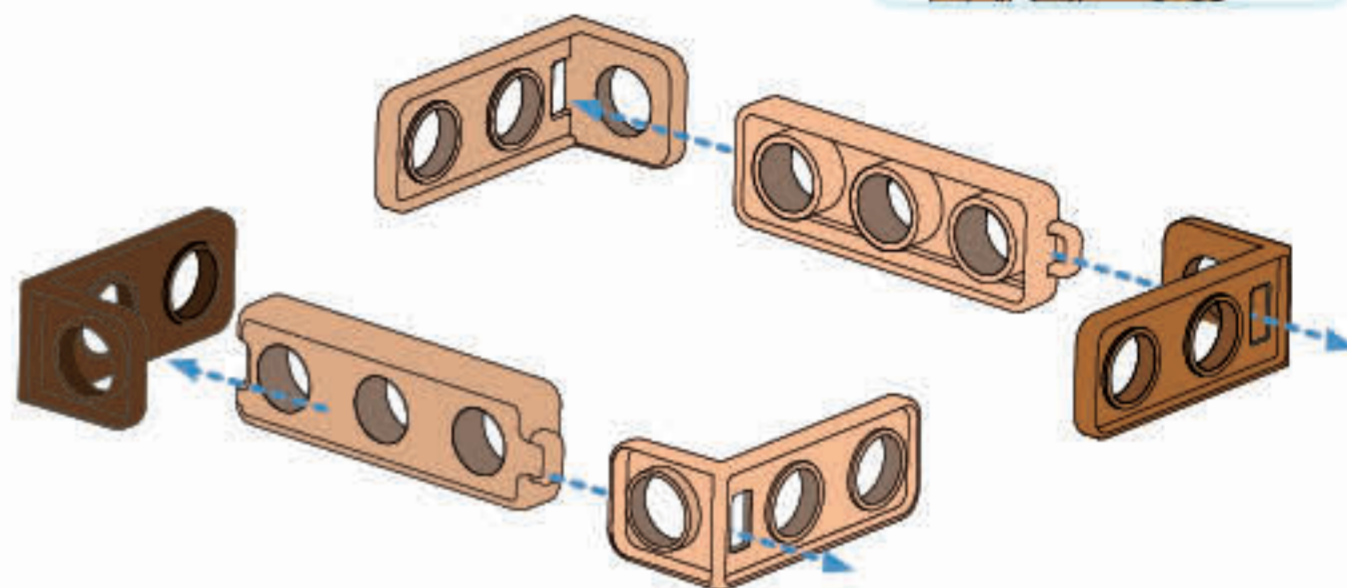
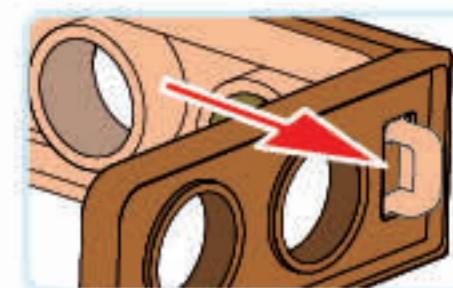
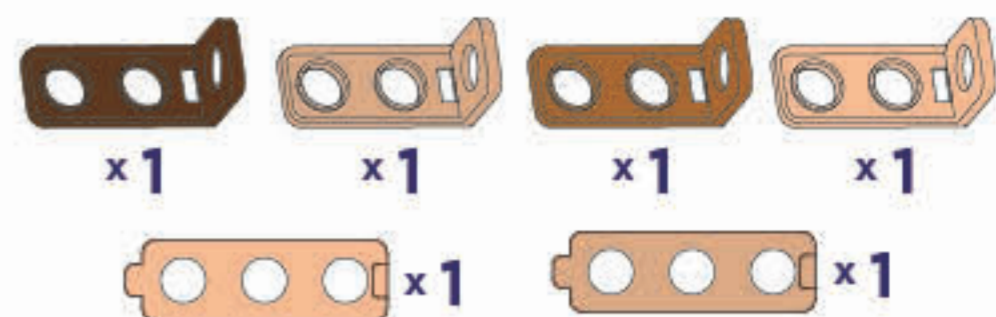

2

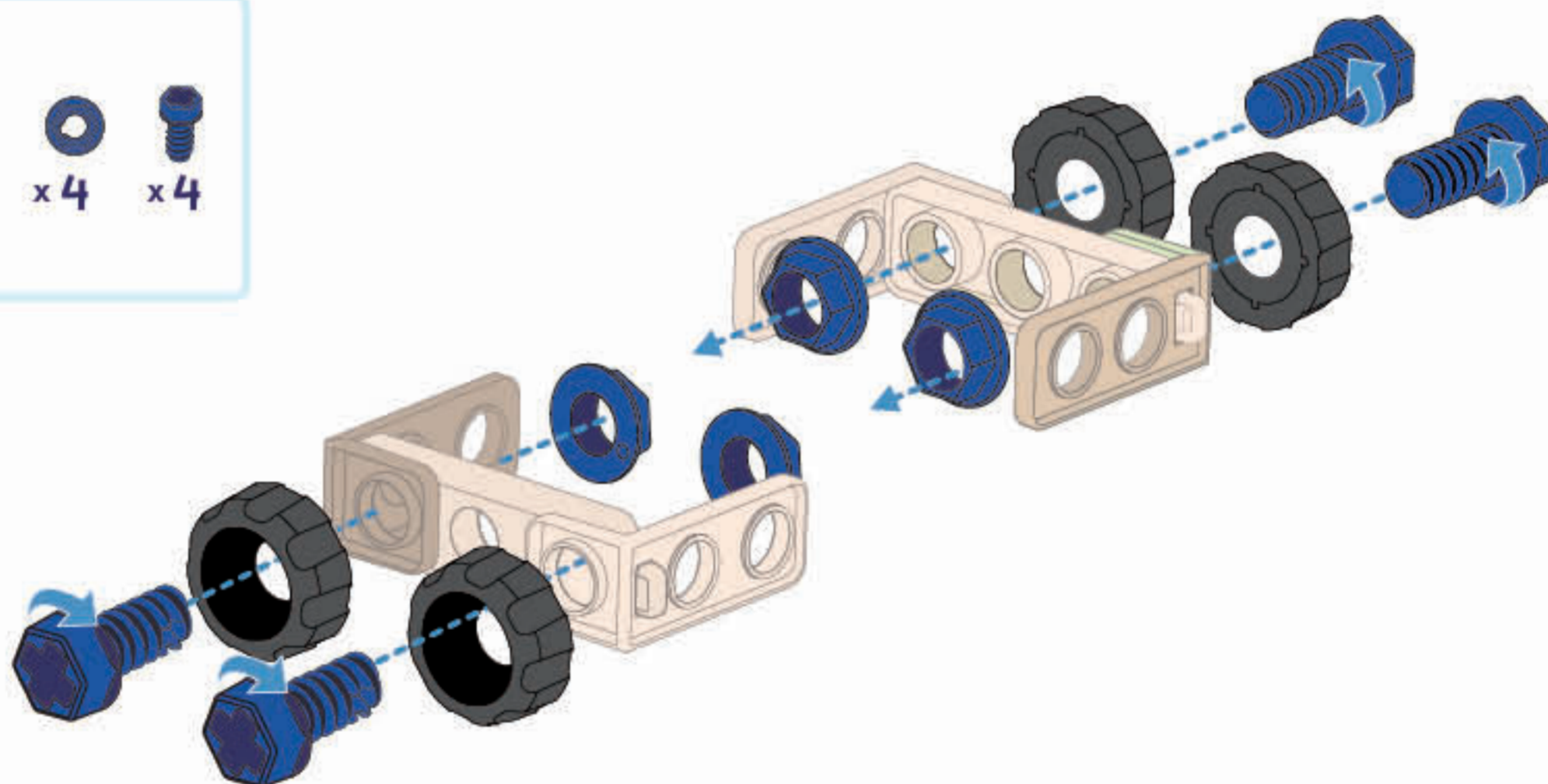

3

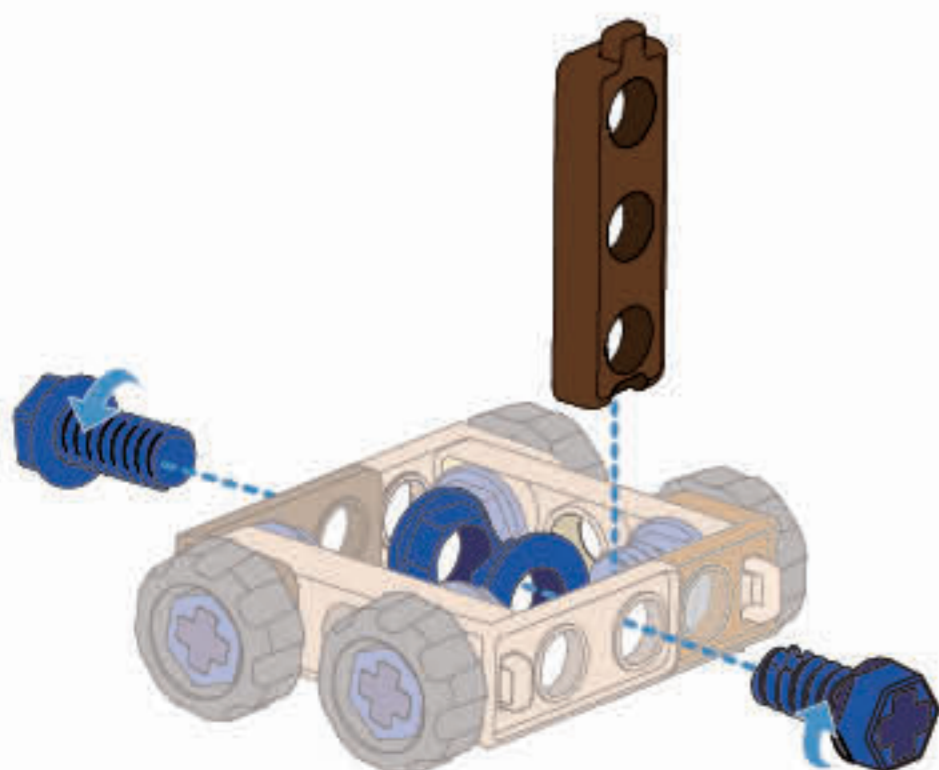

4

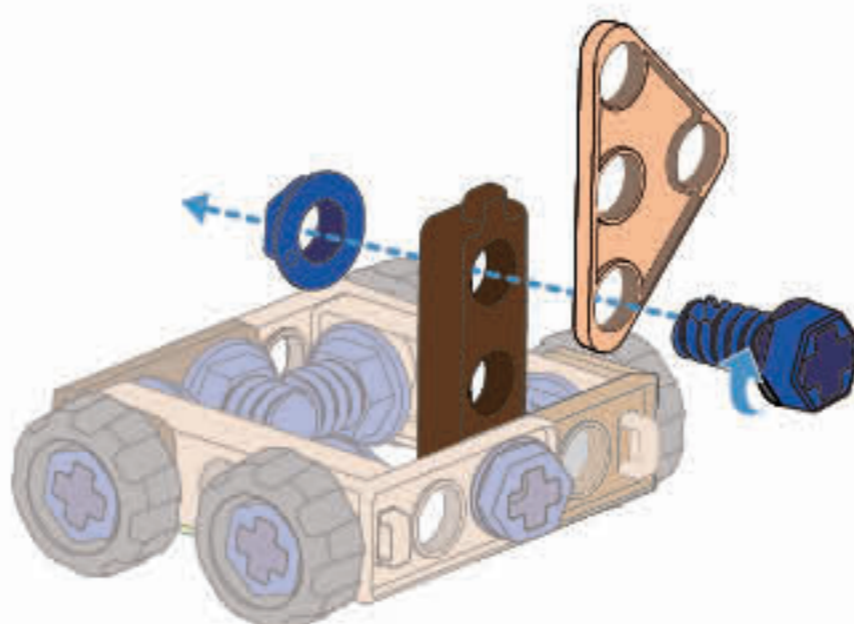

Goed werk!
Het is je gelukt!



014

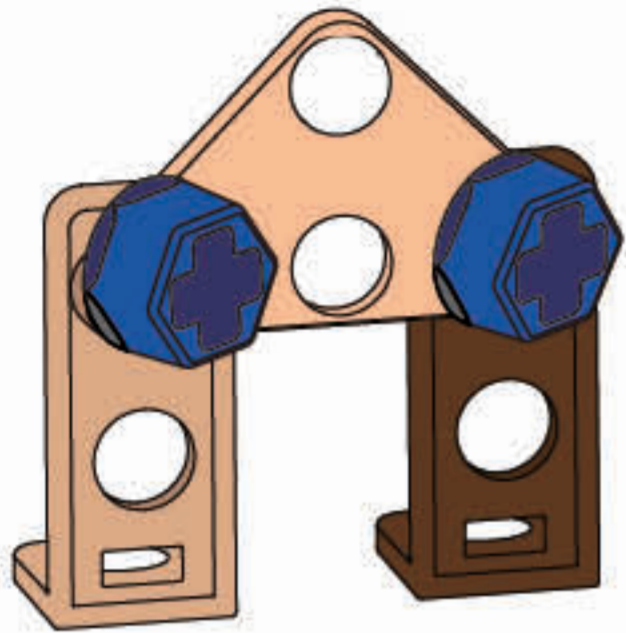
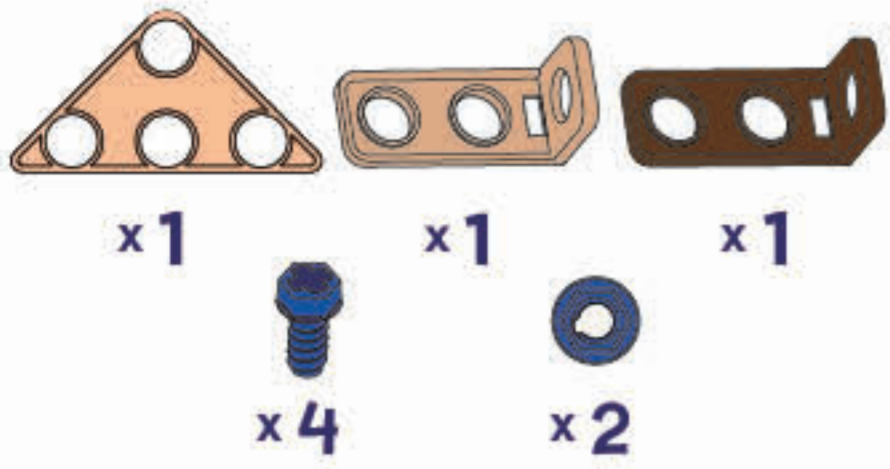

1

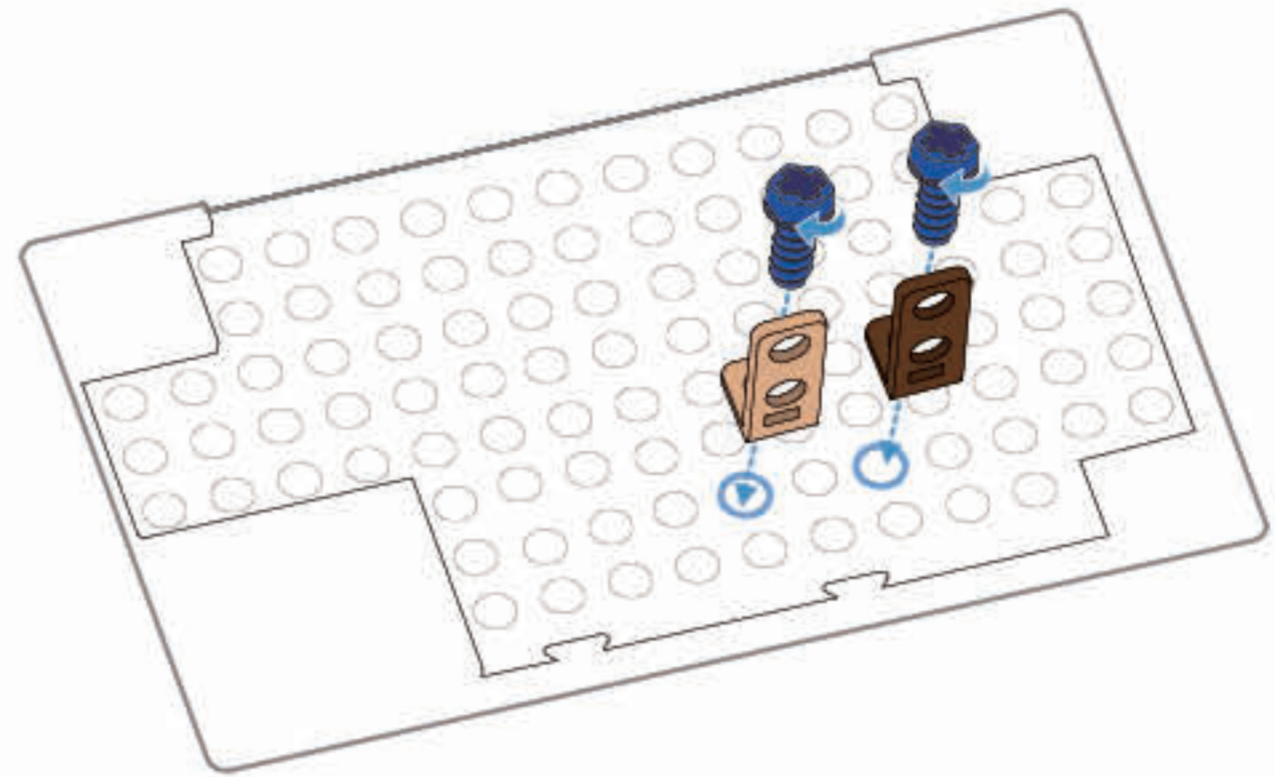
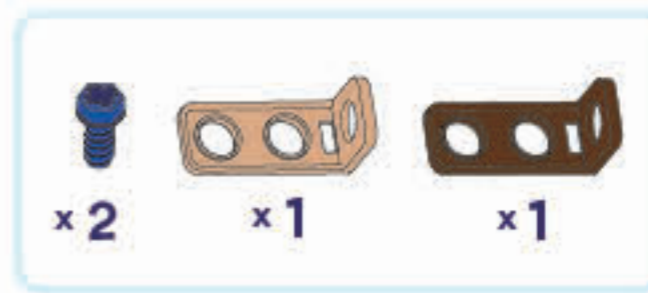

2

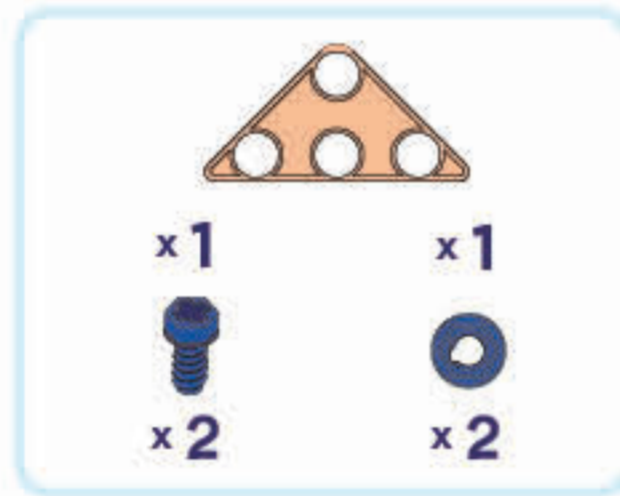

Achterkant

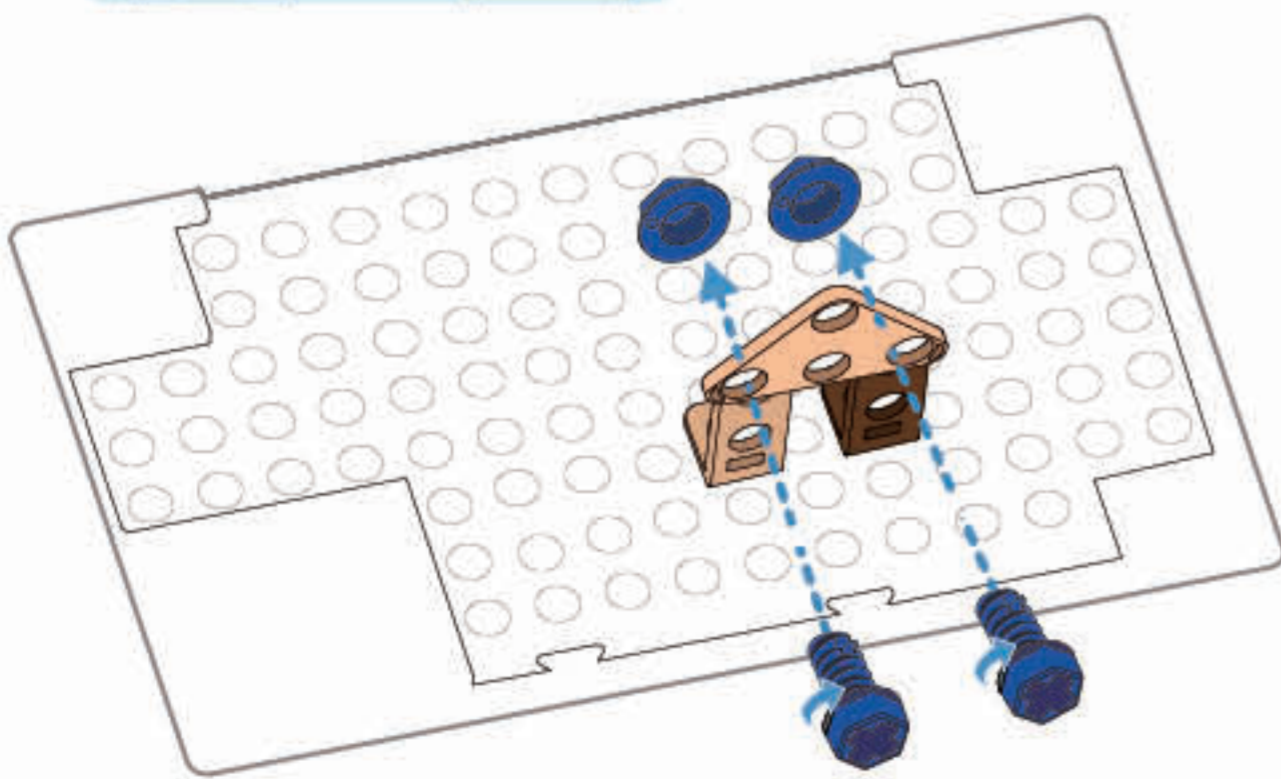
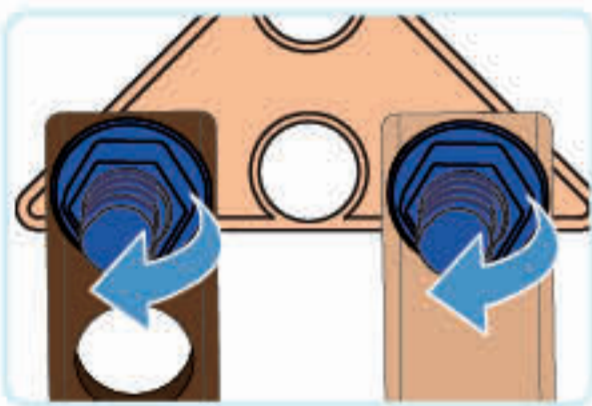

Goed werk!
 Het is je gelukt!



4

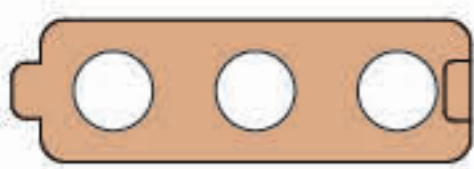

x 1



x 1



x 2



x 2



x 1

Achterkant

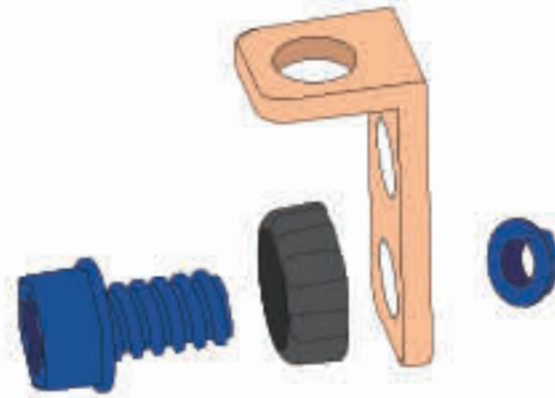
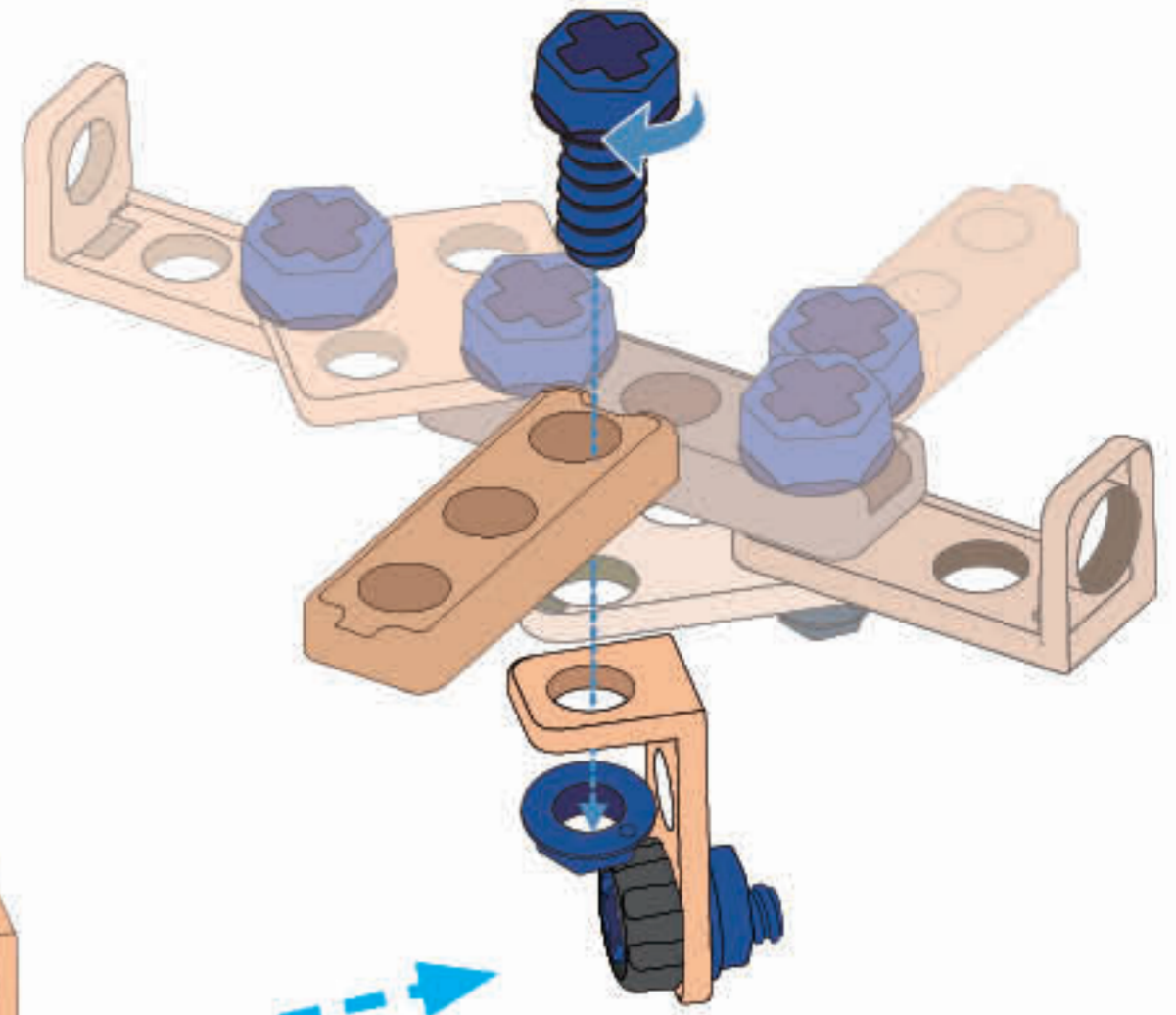
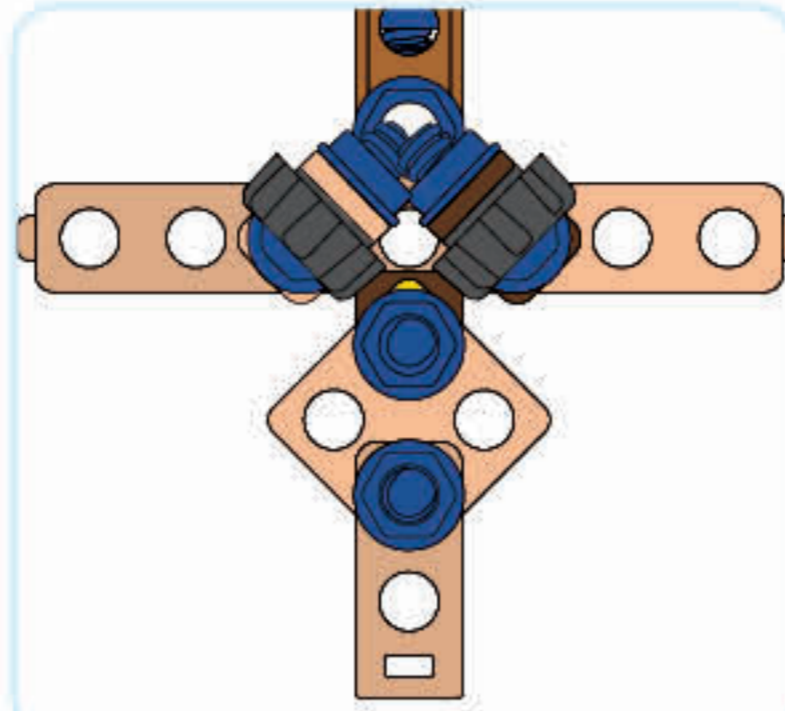

5

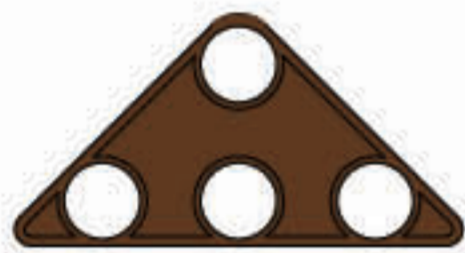

x 1

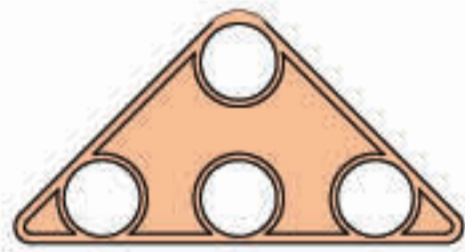

x 1



x 1



x 1

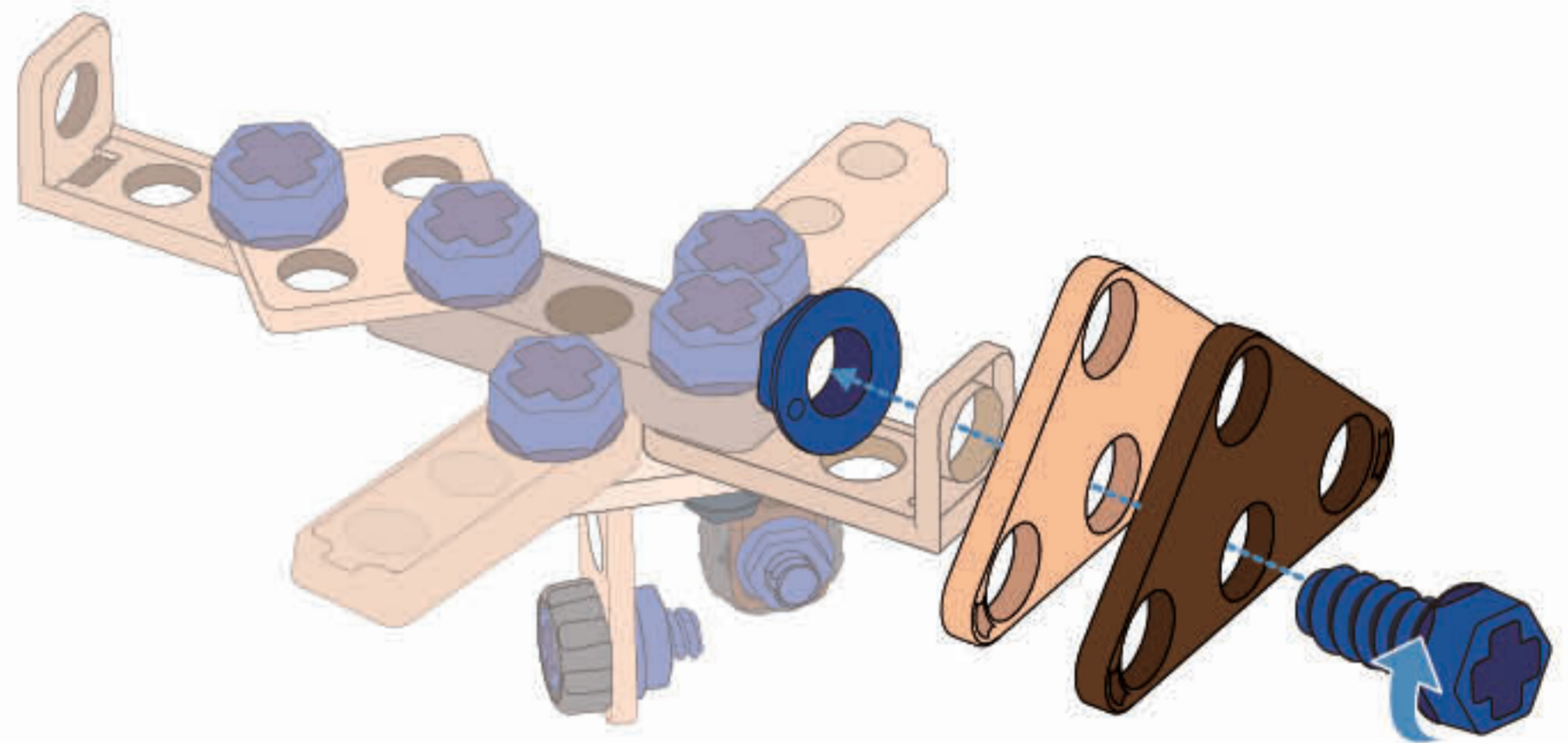

Goed werk!
Het is je gelukt!

